

CHAPTER 32

VIBRATOR POWER SUPPLIES

By R. J. RAWLINGS, Grad. I.E.E., Associate Brit. I.R.E

Section	Page
1. Vibrators—general principles	1202
2. Vibrator transformer design	1205
3. Timing capacitance	1207
4. Elimination of vibrator interference	1210
5. 12, 24 and 32 volt vibrator supplies	1211
6. References	1212

SECTION 1 : VIBRATORS—GENERAL PRINCIPLES

(i) Operation (ii) Vibrator types (iii) Choice of vibrator (iv) Coil energizing
(v) Waveform and time efficiency (vi) Standards for vibrators for auto-radio.

(i) Operation

The vibrator consists essentially of a vibrating reed upon which are mounted switching contacts. By the method of connection in a battery circuit, these contacts enable the direct battery voltage to be converted into an approximate square wave. This can then be transformed and rectified to obtain a plate voltage supply. The standard type vibrators operate at a frequency between 100 and 120 c/s. High frequency types operating about 250 c/s are available for special applications.

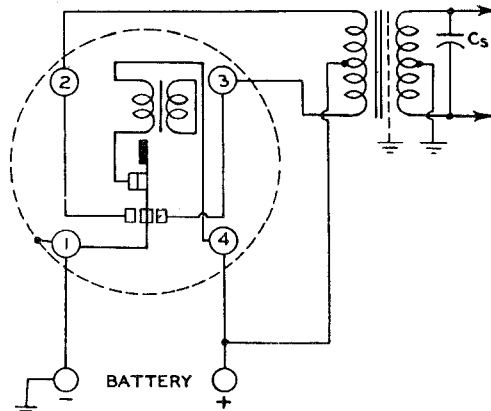

FIG. 32.1 INTERRUPTER TYPE VIBRATOR.

(ii) Vibrator types

There are three basic types of vibrator and these are shown with their circuit connections in Figs. 32.1—32.3.

Fig. 32.1 shows the interrupter (non-synchronous) vibrator which acts as a single pole double throw switch, leaving rectification to be performed by a separate rectifier.

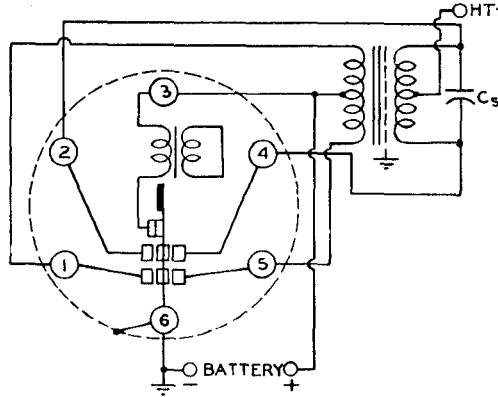

FIG. 32.2 SELF-RECTIFYING TYPE VIBRATOR.

The short-circuited secondary is used by some vibrator manufacturers to reduce the inductance of the energizing winding and hence the sparking of the starting contacts.

Fig. 32.2 gives the circuit arrangement for the self-rectifying (synchronous) vibrator which in addition to switching the primary circuit has a further pair of contacts to provide mechanical rectification of the transformer secondary voltage.

The third type, Fig. 32.3, is a modification of the synchronous type in which, by splitting the vibrating reed, the primary and secondary circuits are isolated from each other.

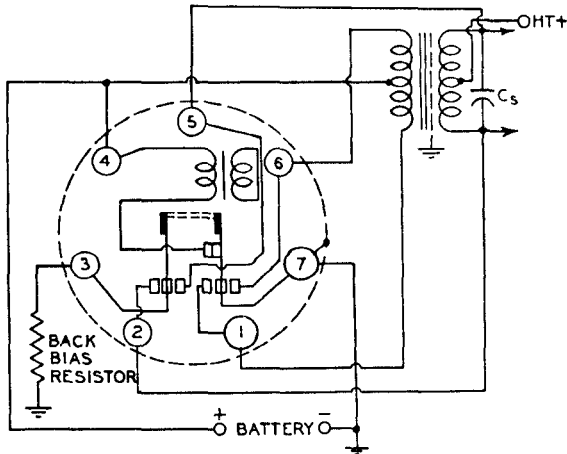

FIG. 32.3 SPLIT-REED SELF-RECTIFYING TYPE VIBRATOR.

(iii) Choice of vibrator

The choice of the type of vibrator to be used will depend upon the application for which it is required.

Where vibrator equipment has to operate with either positive or negative earthed systems, either the interrupter type with a valve rectifier or the reversible self-rectifying type must be used. This latter type is a standard self-rectifying vibrator which can be fitted into its socket in two positions, by rotation through 180°. The use of

these two positions enables the correct output polarity to be obtained from either positive or negative earthed supplies.

In the self-rectifying type, the elimination of the rectifier valve reduces the overall size, power consumption* and heating of the equipment, although at the expense of increased difficulty in hash elimination and, perhaps, of some of the reliability of the non-synchronous type.

The use of split-reed synchronous vibrators allows greater circuit flexibility, particularly in cases in which one model of radio receiver is to be used with dry-battery or vibrator-operated power supplies.

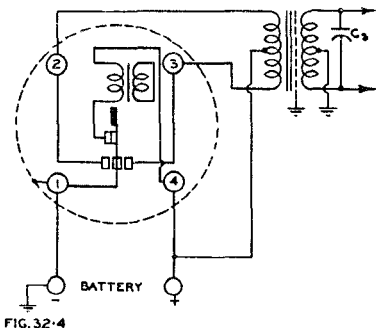

Fig. 32.4. Separate driver system energizing.

(iv) Coil energizing

There are three possible methods—Fig. 32.4 shows the separate driver system energizing while Fig. 32.5A shows shunt energizing with separate starting contacts, and Fig. 32.5B is the conventional shunt energizing arrangement. With the separate driver system, the coil is operated by only the battery voltage; in the conventional shunt connection the coil is operated by greater than the battery voltage due to the auto-transformer action of the transformer primary.

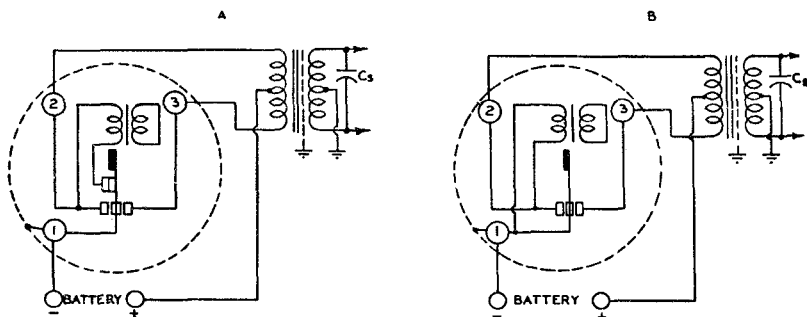

Fig. 32.5. Two alternative methods of shunt coil energizing; (A) with separate starting contacts (B) conventional shunt energizing.

The advantage claimed for the separate driver system energizing and also for the arrangement shown in Fig. 32.5A, is that as the coil current is not switched by the power contacts, good starting will be obtained even towards the end of life or at low battery voltages. This is not the case in Fig. 32.5B in which the starting performance is dependent upon the condition of the power contacts.

*If a cold-cathode rectifier is used the power consumption of synchronous and non-synchronous types should be the same.

(v) Waveform and time efficiency

The general waveform of a vibrator output voltage is given in Fig. 32.6 ; the periods t_2 and t_4 are referred to as the " off contact " time interval. For reasons of consistent operation with life, these times $t_2 + t_4$ are made from 10% to 30% of the total duration of the cycle. The remaining part of the cycle $t_1 + t_3$, which is the " on contact " time, is therefore from 70% to 90% of the cycle and its value is known as the " time efficiency."

The relationships between the peak, average and r.m.s. values of the vibrator waveform are given below—

$$\begin{aligned} \text{Peak value} &= E_b \\ \text{R.M.S. value} &= \sqrt{\omega_t E_b} \\ \text{Average value} &= \omega_t E_b \\ \text{Form factor} &= \sqrt{\omega_t / \omega_i} \end{aligned}$$

where E_b is the battery voltage and ω_t is the time efficiency expressed as a decimal.

The rectangular waveform will be modified to a certain degree by the timing capacitance (see Sect. 3) and will take the approximate form of the dotted curve in Fig. 32.6. This change will not greatly affect the relationships given above.

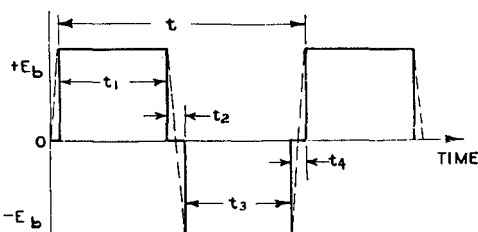

FIG. 32.6

(vi) Standards for vibrators for auto radio

Extract from R.M.A. Standard REC-113—" Vibrating interrupters and rectifiers for auto radio—frequency 115 cycles " (April 1948).

Voltage ratings—nominal 6.3, operating 5.0 to 8.0 volts. Reed frequency at 6.3 volts : 115 ± 7 c/s. See Standard for enclosures, base pins and circuit.

SECTION 2 : VIBRATOR TRANSFORMER DESIGN

(i) *General considerations* (ii) *Transformer calculations* (iii) *Standards for vibrator power transformers.*

(i) General considerations

There are many considerations in vibrator transformer design which require particular attention as against a similar transformer used on a sinusoidal supply. However see also Chapter 5 Sect. 5 for power transformer design.

For a given power output the vibrator transformer will be of greater size for a number of reasons. Half the primary is inactive at any instant due to the need for a centre-tapped winding to obtain the necessary flux reversal. The primary winding should be designed to have the minimum possible resistance, in order that as large a portion of the battery voltage as possible is available for transformation. This means the use of a wire of large diameter with a correspondingly poor space factor. Electrostatic shields between the windings, which are sometimes used to assist in the elimination of hash, also add to the size.

An important point in the transformer design which affects the life of the vibrator is the value of primary leakage inductance. This leakage inductance component in the primary circuit can resonate with the reflected value of the timing capacitance

to produce an undesired damped oscillation, while possible insulation breakdown and contact arcing may result. Therefore where practicable a winding of the pancake type should be used, or else the winding shown in Fig. 32.7, the windings being arranged so that the active sections of the primary and secondary are always adjacent. When manufacturing economy requires the use of the cheapest form of winding, best results are obtained by winding the two halves of the primary first and then the two halves of the secondary. This gives lower leakage reactance than the reverse type of winding.

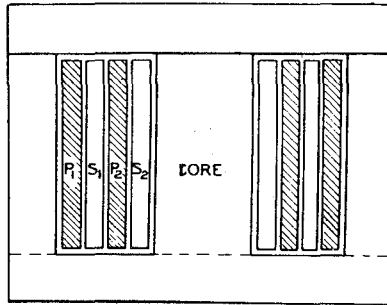

FIG. 32.7

The secondary insulation should be good enough to prevent the risk of a voltage breakdown caused by any irregularity occurring in the vibrator during life which may cause high transient voltages to be developed.

As the magnetizing current of a vibrator transformer has to be supplied by the battery, this represents a power loss and it should be reduced to the minimum possible value—for further details see Sect. 3(iv). This can be done by keeping the flux density B at a low value. The value of B will depend upon the primary voltage, all other quantities being fixed. This value of primary voltage is subject to considerable variations; e.g. from 5.5 to 7.5 volts on a car radio input when a voltage regulator is fitted to the battery charging system, and this may rise to 9.0 volts without the regulator. In the general case the transformer may be designed to have satisfactory characteristics at a maximum of 8 volts.

A high value of magnetizing current also limits the maximum output available from the vibrator. This is because the magnetizing current has to be handled by the primary contacts whose current carrying capacity is limited, thus reducing the current rating available for the load.

(ii) Transformer calculations

The equation for vibrator transformers is

$$N_p = \frac{E \cdot \omega_t \cdot 10^8}{4f \cdot B \cdot A} \quad (1)$$

where E = highest battery voltage at which satisfactory operation is required

ω_t = vibrator time efficiency expressed as a decimal

f = vibrator frequency in cycles per second

A = effective cross sectional area (i.e. actual cross sectional area \times the stacking factor) in sq. inches

B = flux density in lines per sq. inch

and N_p = "effective" number of primary turns (i.e. $\frac{1}{2}$ total primary turns).

The value of A can be estimated from the relationship

$$A = \sqrt{W}/5.58 \text{ sq. ins.} \quad (2)$$

where W = primary watts under full load.

The r.m.s. value of the transformer primary current is given by

$$|I_b| = (\sqrt{\omega_t / \omega_t}) \bar{I}_b \quad (3)$$

where \bar{I}_b = average battery current in amperes.

For values of $\omega_t \geq 0.8$, $\sqrt{\omega_t}/\omega_t \approx 1$ and $|I_b| = \bar{I}_b$.

This value of current can be used in the calculation of the required wire diameter.

As the primary is of heavy gauge wire, and has to be centre tapped, it is of advantage to have an even number of primary layers; this brings the centre tap to the outside of the winding. Therefore when commencing the design, where possible it is of advantage to choose the total number of turns ($2N_p$) to give an even number of layers. The required effective cross sectional area of the core is then given by

$$A = E \omega_t 10^6 / (4fBN_p) \quad (4)$$

(iii) Standards for vibrator power transformers

R.M.A. Standard REC-119 "Vibrator power transformers" (Sept. 1948) gives purchase specifications, performance specifications, test equipment and procedure.

SECTION 3 : TIMING CAPACITANCE

(i) The use of the timing capacitance (ii) Calculation of timing capacitance value
(iii) Percentage closure (iv) Effect of flux density on timing capacitance value.

(i) The use of the timing capacitance

The usual simplified form of the vibrator voltage wave is shown in Fig. 32.8. The dotted curve shows the damped oscillation obtained by the addition of the timing capacitance. In actual operating this oscillation will be suppressed at C when the other contacts connect the battery to the other half of the transformer. The oscillation is shown in full in Fig. 32.8 to illustrate how the first part of the cycle is operative in automatically reversing the battery voltage, so that there is zero potential across the contacts when they make.

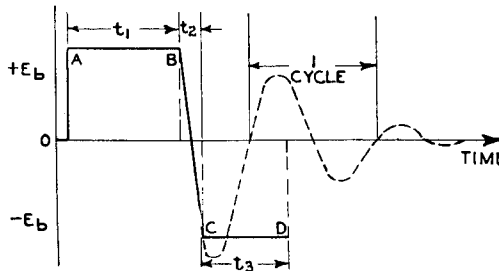

FIG. 32.8

(ii) Calculation of timing capacitance value

The value of the timing capacitance, to give the correct frequency of oscillation for the conditions above, is given by

$$C_p = \frac{H.l_m(1 - \omega_t)10^6}{8N_p.f.E} \mu\text{F} \quad (5)$$

where l_m = length of magnetic path in inches

and H = the value given by the BH curves for the transformer iron being used, at the value of B corresponding to the voltage E in the equation above.

The equation will give the required value of timing capacitance C_p to be used across the primary. For reasons of size and economy, it is usual for the timing capacitance to be placed across the secondary. The value of the equivalent secondary capacitance C_s will be $C_p/(N_s/N_p)^2$ microfarad.

While these equations will give an approximation to the required value of timing capacitance, some modification of this value will be required in practice. The final

value should not be decided, until after examination of the voltage waveform obtained. This test should be carried out with a number of samples of the vibrator which it is intended to use.

(iii) Percentage closure

When the waveform of Fig. 32.8 is obtained, by the correct choice of timing capacitance, there is said to be 100% closure. Figs. 32.9 and 32.10 illustrate the effects of over- and under-closure respectively.

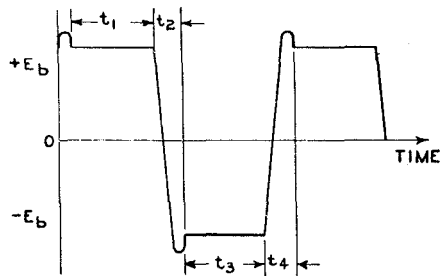

FIG. 32.9

As the effect of overclosure is to produce high transient voltages, and as during life the tendency is for t_1 and t_2 to become shorter, the vibrator will rapidly deteriorate. By aiming at slight under-closure the effect during life is for conditions to approach 100% closure.

For this reason a value of approximately 65% closure is chosen for an average case, as shown in Fig. 32.10A—this means a larger value of timing capacitance than indicated by eqn. (5).

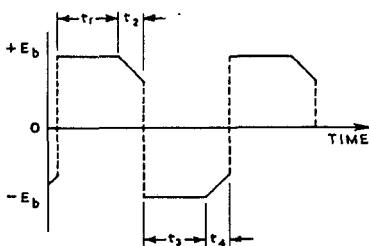

FIG. 32.10

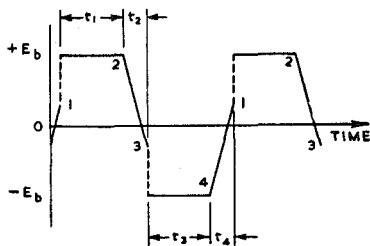

FIG. 32.10A

(iv) Effect of flux density on timing capacitance value

The equation for the timing capacitance shows the need for the careful choice of the value of flux density used in the transformer design. For it will be seen that a change in the ratio of H/E in eqn. (5), such as will take place when working on the curved characteristic of the BH curve, will result in different values of timing capacitance being required at different loads. If the value of H/E is to be kept constant, B must be directly proportional to H over the working range. Examination of Fig. 32.11 will show that this is not the case, even on the straight portion of the BH curve, as a line drawn through the straight portion of the curve would not originate at the junction of the X and Y axes. A more exact approximation to the desired condition can be obtained by working around the knee of the curve; operation at this point will result in greater economy of iron.

In Fig. 32.11 the line OY has been drawn so that the deviation of the BH curve from the ideal curve OY is such that the values AA' , BB' and CC' when transferred to the H scale, represent equal values—in this case $7\frac{1}{2}\%$ of the nominal value. Thus the timing capacitance does not vary by more than $7\frac{1}{2}\%$ for a variation in flux from

32.3 (iv) EFFECT OF FLUX DENSITY ON TIMING CAPACITANCE 1209

53 to 81 kilolines/sq. inch. Point A at 71 kilolines/sq. inch would appear to be, in this particular case, the optimum point where a variation of plus 14% and minus 25.5% can be allowed in the value of *B*. If this value of *B* results in an excessive value of magnetizing current, point X corresponding to 61 kilolines/sq. inch could be used.

Likewise any other point could be selected providing other design considerations are satisfied, but the point A represents the optimum as regards the change of timing capacitance with input voltage. The point A can be found for any *BH* curve by suitable positioning of the line *OY*.

It should be noted that having decided on the position of *OY*, and from this deriving the operating centre point, the values of *B* and *H* required for the timing capacitance calculation should be read from the line *OY*.

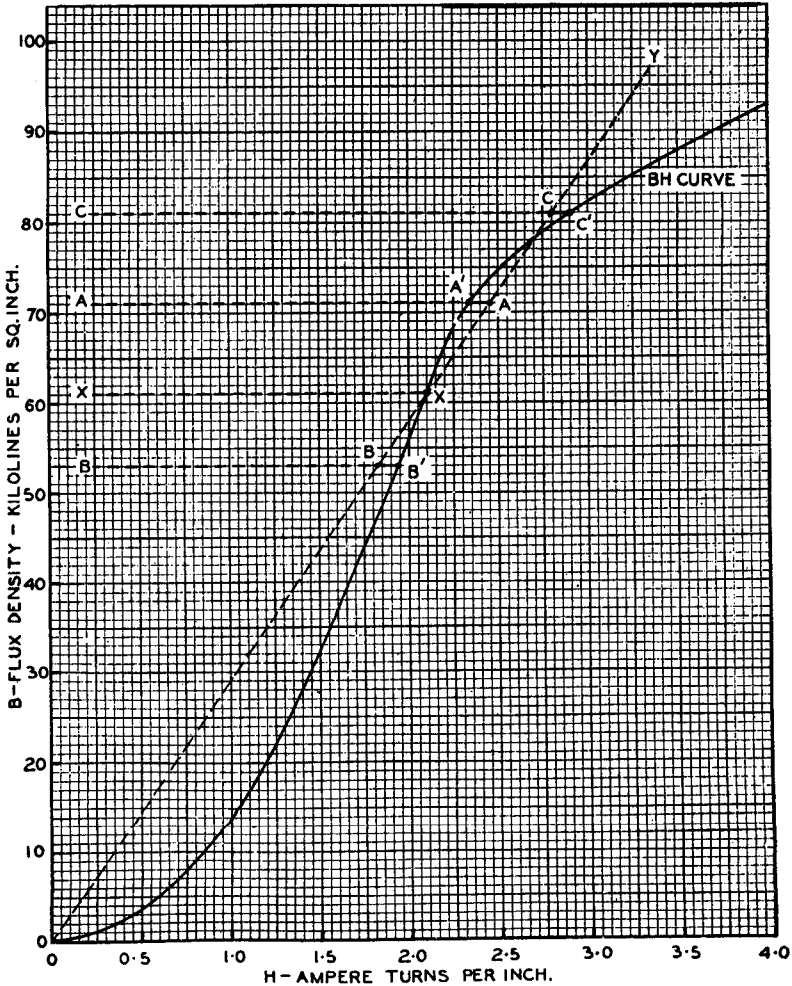

FIG. 32-11

SECTION 4 : ELIMINATION OF VIBRATOR INTERFERENCE

The methods of eliminating vibrator interference can only be stated in general terms and the final arrangement will depend upon the layout and characteristics of the particular power supply. Where the vibrator power supply is not used with a receiver or similar sensitive equipment, the requirements of 'hash' elimination are less stringent provided that there is no danger of interference being introduced into adjacent equipment.

With sensitive receivers, particularly those covering short wave ranges, it is desirable to use a separate shielded chassis for the vibrator power supply as it may otherwise be impossible to eliminate hash at all points in the tuning range with the receiver aerial wrapped around the battery cable and battery, and with the receiver at maximum sensitivity. Such a chassis may be mounted on the main receiver chassis if desired, and in any case a flexible mounting (such as rubber grommets) is useful in reducing mechanical vibration and hum.

When a separate chassis is used a satisfactory method of construction is to have all hot components, vibrator, vibrator transformer and timing capacitors, in a shielded compartment with the leads from this compartment—normally either two or three—by-passed at or near the point of exit and connected to a r-f choke immediately after leaving the compartment. R-F chokes are less useful on the other side of the shield. A common earthing point can still be used for all components by having a solder lug accessible from both sides of the chassis.

It is sometimes found that better hash reduction is obtained with one or more components earthed in isolated places. However the improved results at one frequency are usually at the expense of increased hash at some other frequency. If this is not the case, the earthing point is liable to be critical and perhaps variable from unit to unit, i.e. the improvement is due to cancellation of hash and not to elimination. This is undesirable in prototypes of equipment which is later to be mass-produced.

R-F chokes are liable to have an appreciable field around them and layout must be such as to avoid introducing hash from such fields into circuits which have already been filtered. Special types of by-pass capacitors are available with braided leads to reduce their r-f impedance. These can give a considerable improvement over standard types with wire pigtailed. "Spark plates" are also useful. These are by-pass capacitors using the chassis as one plate, a thin sheet of mica as the dielectric and a sheet of say brass as the "hot" plate, the assembly being held together with insulated eyelets.

Vibrator design is rarely a matter for ingenious circuits. Once the transformer and timing capacitors are correctly specified, layout and shielding are the most important considerations and a minimum cost circuit is usually adequate. If trouble is experienced from hash it is not usual for a cure to result from a mere addition of by-pass capacitors to a circuit which already has a normal complement. For instance a unit in which all outgoing leads are "hot" is more likely (assuming reasonable filtering) to suffer from shielding troubles than from insufficient filtering of the leads in question.

A convenient method for investigating the presence or absence of interference at a particular point in a receiver is to use a probe of shielded wire with the end bared and connected through a capacitor to the aerial terminal of the receiver used with the vibrator unit.

Before hash elimination from a prototype vibrator unit can be considered complete it is necessary to carry out the standard tests with a number of vibrator cartridges, some of which have been in service for long periods. Units in which hash suppression is only sufficient to silence the hash from new vibrator cartridges in good condition may give poor apparent cartridge life owing to the need for replacement as soon as sparking and the consequent interference occur due to slight wear.

In Fig. 32.12 are shown the more usual arrangements and typical circuit values are given as a guide to the choice of suitable components. The timing capacitance is centre-tapped and its centre point is earthed. The two 100 ohm resistors, R_1 and R_2 ,

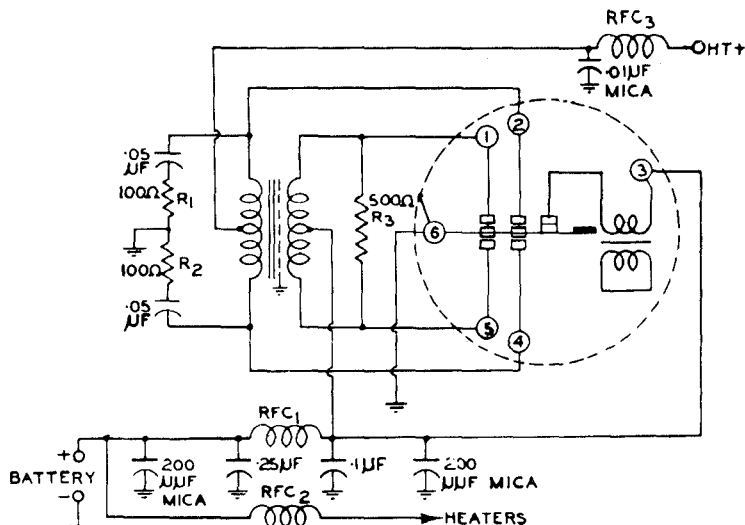

FIG. 32-12 TYPICAL VIBRATOR POWER SUPPLY SHOWING INTERFERENCE SUPPRESSION COMPONENTS

are not for hash elimination but to protect the vibrator transformer in the event of a timing capacitance short-circuiting. RFC_1 and RFC_2 are low resistance r-f chokes made of heavy gauge wire. RFC_1 prevents interference being fed back along the battery leads which could result in these leads radiating interference to the aerial. RFC_2 prevents interference entering the r-f section of the receiver through the heater wiring. RFC_3 , a standard receiver r-f choke, is to eliminate interference frequencies in the plate voltage supply. The resistor R_3 is useful in eliminating the strong impulse interference which usually exists, although at the expense of some battery current. Alternatively, two separate resistors in series may be used across the primary contacts, the centre point of these being earthed.

In 12, 24 and 32 volt systems where part of the timing capacitance is usually placed across the primary circuit to aid starting, this capacitance has been found to be effective in reducing interference. This method can be used for 6 volt systems to reduce the interference, but if the transformer has considerable leakage inductance increased trouble may be experienced with spurious resonances—see Sect. 2(i).

SECTION 5 : 12, 24 and 32 VOLT VIBRATOR SUPPLIES

While the higher voltage of the 12, 24 and 32 volt systems has some advantages over the 6 volt systems, special precautions are necessary if successful vibrator operation is to be obtained.

The higher voltage and consequently lower current, for the same power input, reduce the percentage voltage drop in the battery leads. The larger number of primary turns which are required results in an improved space factor and the centre tapping of the primary winding is made easier because of the larger number of layers and smaller wire diameter.

Against these advantages are the disadvantages of the additional circuit arrangements required for limiting the current during the starting period. Owing to the higher voltages existing across the contacts, ionization of the air between them will

more readily take place. This condition is particularly serious on starting where the correct conditions for the vibrator have not stabilized and heavy currents may flow.

Fig. 32.13 shows a method of overcoming this difficulty, a three position switch being used to introduce some resistance into the battery lead for the starting condition.

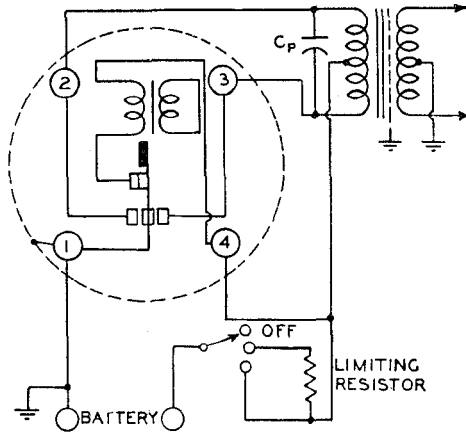

FIG. 32-13 STARTING ARRANGEMENTS FOR 24 AND 32 VOLT VIBRATORS.

Condensers across the contacts to suppress the arc are not to be recommended unless the minimum value that just suppresses the arc is used. By splitting the timing capacitance and placing part of it across the primary, arcing can be reduced. If this is done, consideration should be given to possible resonances with the primary leakage inductance due to imperfect addition of the split timing capacitance—see Sect. 2(i).

We wish to give acknowledgment to P. R. Mallory and Co., Inc., for much of the information and some of the diagrams in this Chapter, which have been adapted from their publication "Fundamental Principles of Vibrator Power Supply Design."

SECTION 6 : REFERENCES

1. "Fundamental Principles of Vibrator Power Supply Design" P. R. Mallory and Co.
2. "RMA Standard vibrator power transformers" REC-119 Sept. 1948 (U.S.A.).
3. Williams, M. R. "Heavy duty vibrator type power supplies" Radio News 35.6 (June 1946) 46.
4. Bell, D. A. "Vibrator power packs" W.W. 54.8 (Aug. 1948) 272.

Additional references will be found in the Supplement commencing on page 1475.