

Service Manual

Cassette Deck

RS-M205

(Silver Face)
(Black Face)

Metal Tape Compatible Stereo Cassette Deck
with Soft-Touch Controls and Rewind
Auto-Play Convenience

 DOLBY SYSTEM



This is the Service Manual for the following areas.

- For all European areas except United Kingdom.
- For Asia, Latin America, Middle East and Africa areas.
- For Australia.

RS-M24 MECHANISM SERIES

Specifications

Track system: 4-track 2-channel stereo recording and playback
Tape speed: 4.8cm/s (1-7/8 ips.)
Wow and flutter: 0.05% (WRMS)
Frequency response: Metal tape; 20—17,000Hz
30—15,000Hz (DIN)
CrO₂ tape; 20—16,000Hz
30—15,000Hz (DIN)
Normal tape; 20—15,000Hz
30—13,000Hz (DIN)
Signal-to-noise ratio: Dolby* NR in; 66 dB (above 5kHz)
Dolby NR out; 56 dB
(signal level=max. recording level, CrO₂ type tape)
Fast forward and
rewind time: Approx. 90 seconds with C-60 cassette tape
Inputs: MIC; sensitivity 0.25mV, input impedance 60kΩ
applicable microphone impedance 400Ω—10kΩ
LINE; sensitivity 60mV, input impedance 47kΩ

Outputs: LINE; output level 400mV, output impedance 1.5kΩ or less, load impedance 22kΩ over HEADPHONES; output level 80mV, load impedance 8Ω
Rec/pb connection: 5 P DIN type; input sensitivity 0.25mV, impedance 5.6kΩ output level 400mV, impedance 1.5kΩ
Bias frequency: 80kHz
Motor: Electrical DC governor motor
Heads: 2-head system;
1-MX head for record/playback
1-double-gap ferrite head for erasure
Power requirements: ... AC; 110/220V, 50-60Hz
 ... AC; 110/125/220/240V, 50-60Hz
 ... AC; 240V
Power consumption: 10W
Dimensions: 43.0cm(W) × 12.2cm(H) × 20.6cm(D)
Weight: 3.9kg

Specifications are subject to change without notice.

* 'Dolby' and the double-D symbol are trademarks of Dolby Laboratories.

Technics

Matsushita Electric Trading Co., Ltd.
P.O. Box 288, Central Osaka Japan

CONTENTS

ITEM	PAGE
LOCATION OF CONTROLS AND COMPONENTS	1
DISASSEMBLY INSTRUCTIONS	2
MEASUREMENT AND ADJUSTMENT METHODS	3
ELECTRICAL PARTS LOCATION	6
SCHEMATIC DIAGRAM	7
CIRCUIT BOARDS AND WIRING CONNECTION DIAGRAM	8
MECHANICAL PARTS LOCATION	9
CABINET PARTS LOCATION	9

LOCATION OF CONTROLS AND COMPONENTS

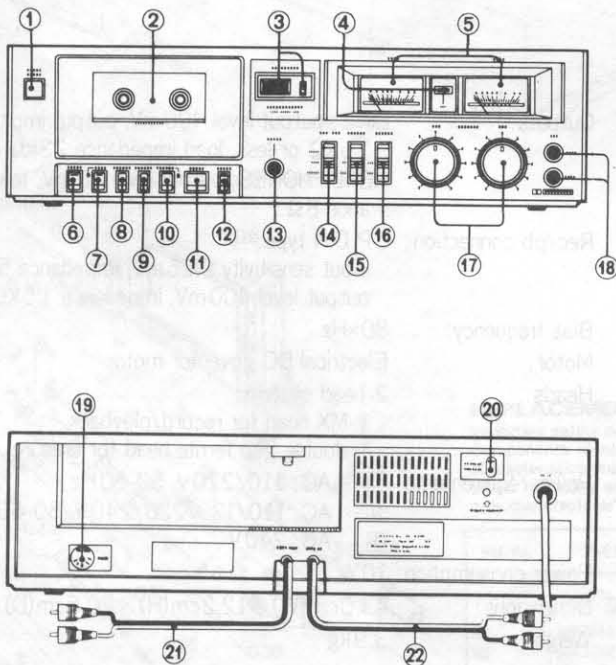

- ① Power switch [power (push on)]
 - ② Cassette holder
 - ③ Tape counter and Reset button (tape counter)
 - ④ Recording indication lamp (rec)
 - ⑤ VU meters (left-level-right)
 - ⑥ Eject button (▲ eject)
 - ⑦ Record button (○ rec-□)
 - ⑧ Rewind/Review button (◀◀ rew/rev)
 - ⑨ Fast forward/Cue button (▶▶ ff/cue)
 - ⑩ Play button (▶ play-□)
 - ⑪ Stop button (■ stop)
 - ⑫ Pause button (|| pause)
 - ⑬ Headhones jack (phones)
 - ⑭ Tape selector [tape select (Metal·CrO₂·Normal)]
 - ⑮ Dolby noise-reduction switch [Dolby NR (in-out)]
 - ⑯ Input selector [input select (line·mic (DIN))]
 - ⑰ Input level controls [input level (left-right)]
 - ⑱ Microphone jacks [mic (left-right)]
 - ⑲ Record/Playback connection socket (REC/PLAY)
 - ⑳ Voltage selector (VOLTAGE SELECTOR)
- * For all European areas except United Kingdom
* For Asia, Latin America, Middle East and Africa areas
- ㉑ Line output cord (LINE OUT)
 - ㉒ Line input cord (LINE IN)

DISASSEMBLY INSTRUCTIONS

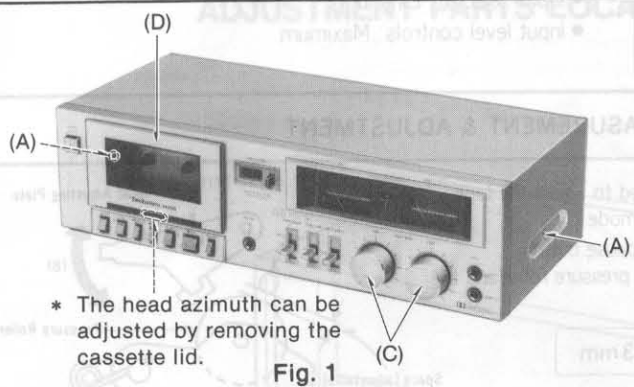

Fig. 1

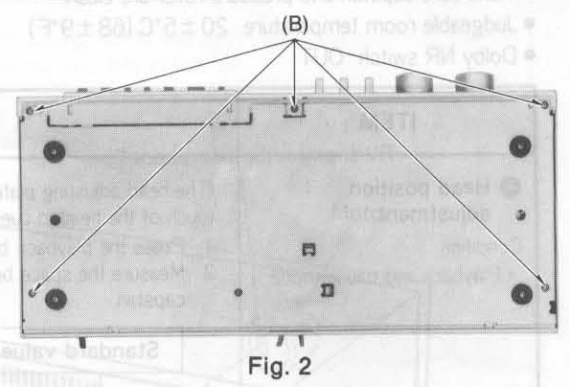

Fig. 2

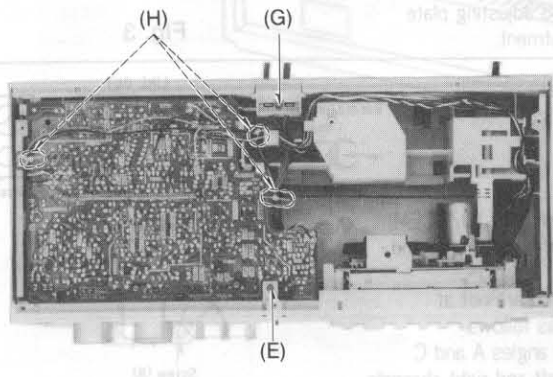

Fig. 3

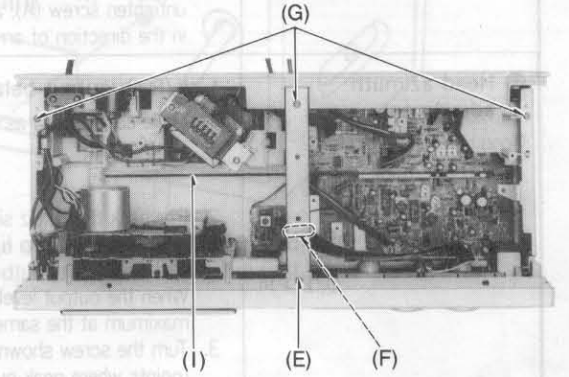

Fig. 4

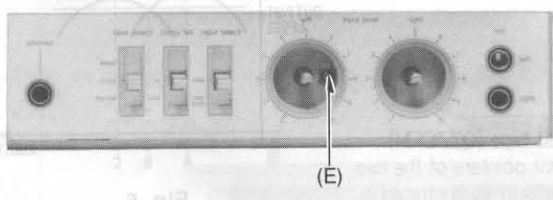

Fig. 5

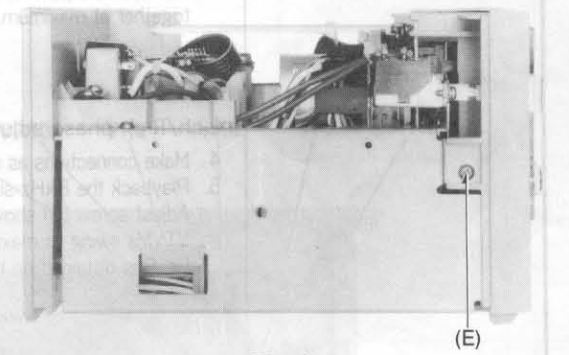

Fig. 6

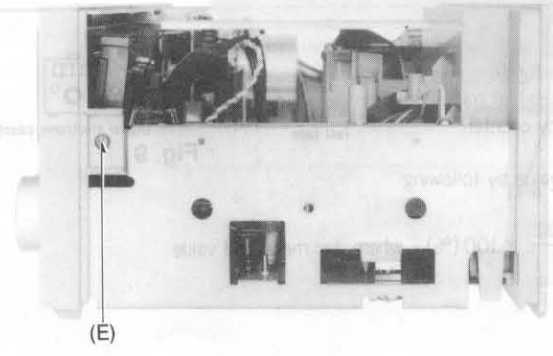

Fig. 7

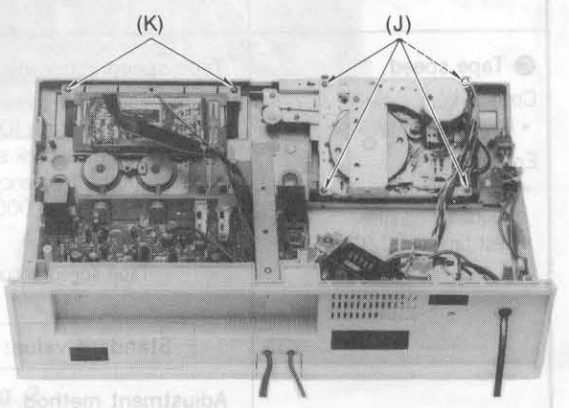

Fig. 8

MEASUREMENT AND ADJUSTMENT METHODS

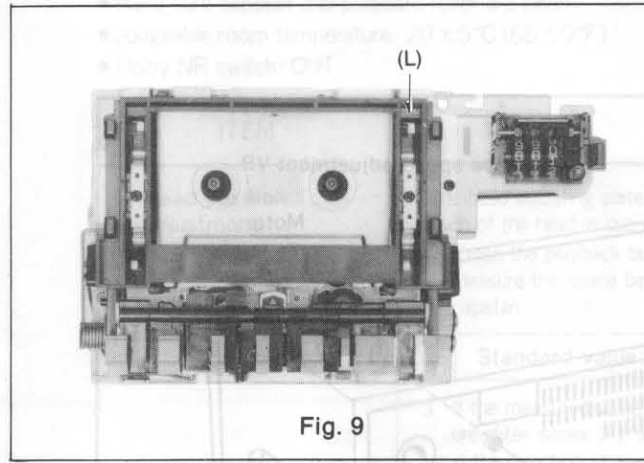

Fig. 9

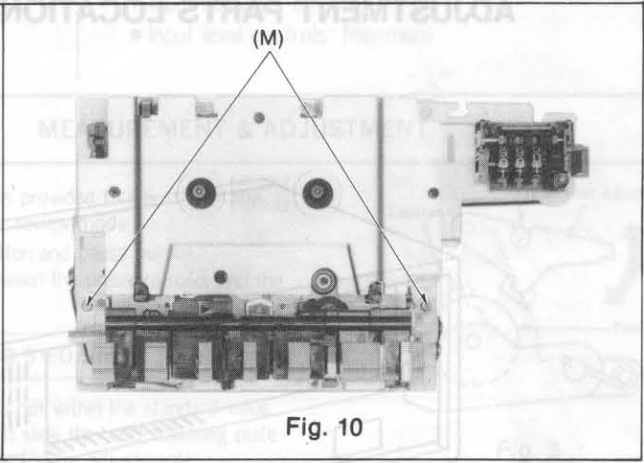

Fig. 10

Ref. No.	Procedure	To remove	Remove	Shown in fig.
1	1	Case cover	• 2 screws (A)	1
2	2	Bottom cover	• 5 screws (B)	2
3	1 → 2 → 3	Front panel	• 2 control knobs (C) • Cassette lid (D) • 5 screws (E) • Binder (F)	1 1 3, 4, 5, 6, 7 4
4	1 → 2 → 4	Back chassis	• 4 screws (G) • 3 binders (H) • Recording wire (I)	3, 4 3 4
5	1 → 2 → 3 → 5	Mechanism unit	• 4 screws (J)	8
6	1 → 2 → 3 → 6	Level meter	• 2 screws (K)	8
7	1 → 2 → 3 → 5 → 7	Operation button unit	• Cassette holder (L) • 2 screws (M)	9 10

MEASUREMENT AND ADJUSTMENT METHODS

ADJUSTMENT PARTS LOCATION

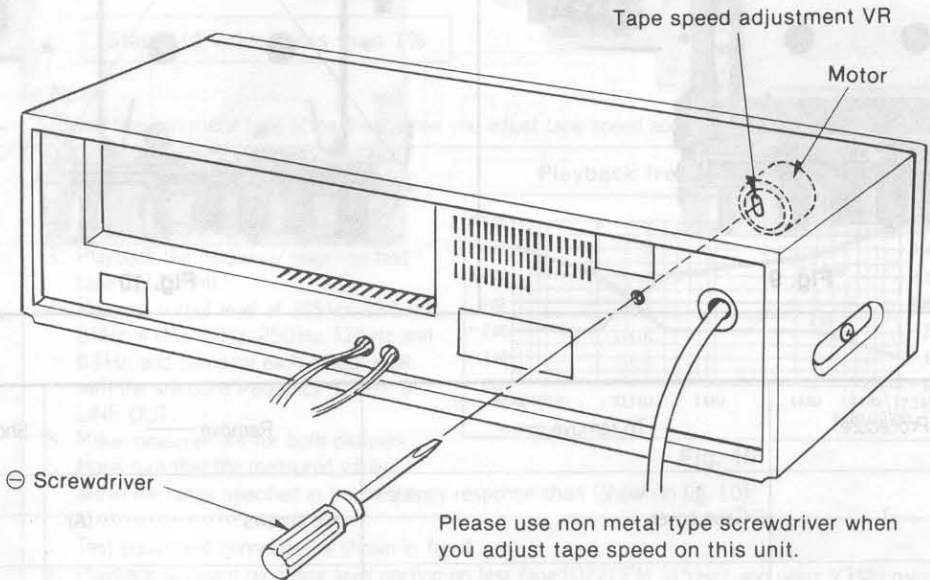

Fig. 1

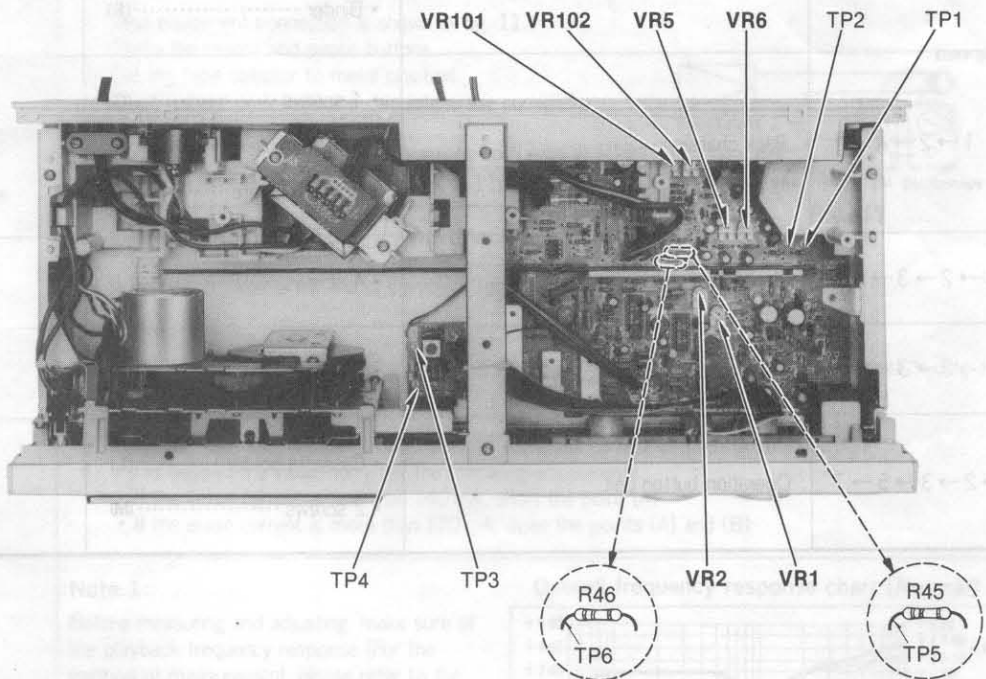
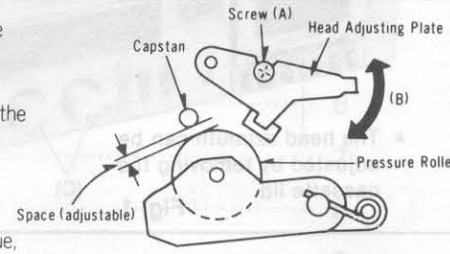
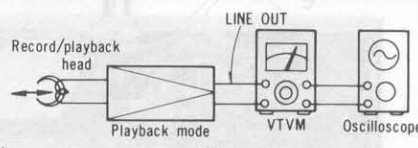
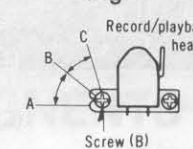
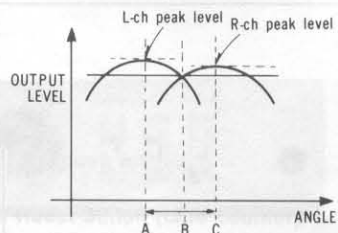
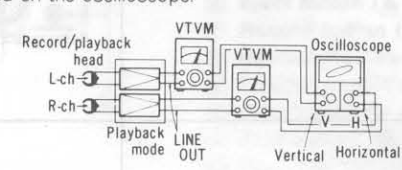
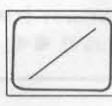
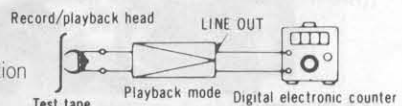
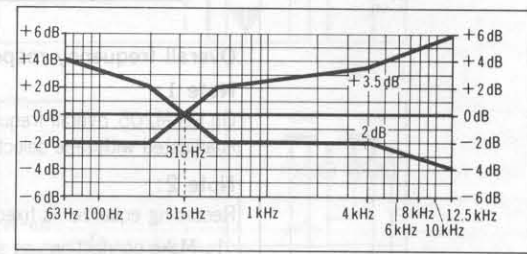
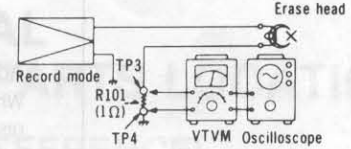
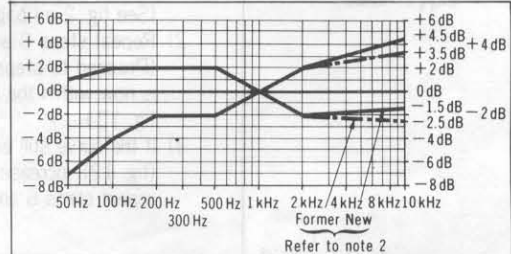

Fig. 2

NOTES: Keep good condition, set switches and controls in the following positions, unless otherwise specified.

- Make sure heads are clean.
- Make sure capstan and pressure roller are clean.
- Judgeable room temperature: $20 \pm 5^\circ\text{C}$ ($68 \pm 9^\circ\text{F}$)
- Dolby NR switch: OUT
- Tape selector: Normal position
- Input selector: Line in
- Input level controls: Maximum

ITEM	MEASUREMENT & ADJUSTMENT
<p>A Head position adjustment</p> <p>Condition:</p> <ul style="list-style-type: none"> • Playback and pause mode 	<p>(The head adjusting plate is provided to adjust the tape touch of the head in cue or review mode.)</p> <ol style="list-style-type: none"> 1. Press the playback button and pause button. 2. Measure the space between the pressure roller and the capstan. <div style="border: 1px solid black; padding: 5px; width: fit-content; margin: 10px auto;"> <p>Standard value: $0.5 \pm 0.3\text{mm}$</p> </div> <ol style="list-style-type: none"> 3. If the measured value is not within the standard value, untighten screw (A), and slide the head adjusting plate in the direction of arrow (B) for adjustment.  <p style="text-align: center;">Fig. 3</p>
<p>B Head azimuth adjustment</p> <p>Condition:</p> <ul style="list-style-type: none"> • Playback mode <p>Equipment:</p> <ul style="list-style-type: none"> • VTVM • Oscilloscope • Test tape (azimuth) ... QZZCFM 	<p>L-ch/R-ch output balance adjustment</p> <ol style="list-style-type: none"> 1. Make connections as shown in fig. 4. 2. Playback the 8kHz signal from the test tape (QZZCFM). Adjust screw (B) in fig. 5 for maximum output L-ch and R-ch levels. <p>When the output levels of L-ch and R-ch are not at maximum at the same time, readjust as follows.</p> <ol style="list-style-type: none"> 3. Turn the screw shown in fig. 5 to find angles A and C (points where peak output levels for left and right channels are obtained). Then, locate the angle B between angles A and C, i.e., a point where L-ch and R-ch output levels come together at maximum. (Refer to figs. 5 and 6.) <p>L-ch/R-ch phase adjustment</p> <ol style="list-style-type: none"> 4. Make connections as shown in fig. 7. 5. Playback the 8kHz signal from the test tape (QZZCFM). Adjust screw (B) shown in fig. 5 so that pointers of the two VTVMs swing to maximum and a waveform as illustrated in fig. 8 is obtained on the oscilloscope.  <p style="text-align: center;">Fig. 4</p>  <p style="text-align: center;">Fig. 5</p>  <p style="text-align: center;">Fig. 6</p>  <p style="text-align: center;">Fig. 7</p>  <p style="text-align: center;">Fig. 8</p>
<p>C Tape speed</p> <p>Condition:</p> <ul style="list-style-type: none"> • Playback mode <p>Equipment:</p> <ul style="list-style-type: none"> • Digital electronic counter or frequency counter • Test tape ... QZZCWAT 	<p>Tape speed accuracy</p> <ol style="list-style-type: none"> 1. Test equipment connection is shown in fig. 9. 2. Playback test tape (QZZCWAT 3,000Hz) at middle section and supply playback signal to frequency counter. 3. Measure this frequency. 4. On the basis of 3,000Hz, determine value by following formula: $\text{Tape speed accuracy} = \frac{f - 3,000}{3,000} \times 100 (\%) \quad \text{where, } f = \text{measured value}$ <div style="border: 1px solid black; padding: 5px; width: fit-content; margin: 10px auto;"> <p>Standard value: $\pm 1.5\%$</p> </div> <p>Adjustment method</p> <ol style="list-style-type: none"> 1. Playback the test tape (middle) 2. Adjust so that frequency becomes 3,000Hz 3. Tape speed adjustment VR shown in fig. 1.  <p style="text-align: center;">Fig. 9</p>

ITEM	MEASUREMENT & ADJUSTMENT
	<p>Tape speed fluctuation</p> <p>Make measurements in same manner as above (beginning, middle and end of tape), and determine the difference between maximum and minimum values and calculate as follows:</p> $\text{Tape speed fluctuation} = \frac{f_1 - f_2}{3,000} \times 100 (\%) \quad f_1 = \text{maximum value, } f_2 = \text{minimum value}$ <p style="text-align: center;">Standard value: Less than 1%</p> <p>Note: Please use non metal type screwdriver, when you adjust tape speed accuracy on this unit.</p>
<p>D Playback frequency response</p> <p>Condition:</p> <ul style="list-style-type: none"> • Playback mode • Tape selector ... Normal position <p>Equipment:</p> <ul style="list-style-type: none"> • VTVM • Oscilloscope • Test tape... QZZCFM 	<p>1. Test equipment connection is shown in fig. 4.</p> <p>2. Place UNIT into playback mode.</p> <p>3. Playback the frequency response test tape (QZZCFM).</p> <p>4. Measure output level at 315Hz, 12.5kHz, 8kHz, 4kHz, 1kHz, 250Hz, 125Hz and 63Hz, and compare each output level with the standard frequency 315Hz, at LINE OUT.</p> <p>5. Make measurement for both channels.</p> <p>6. Make sure that the measured value is within the range specified in the frequency response chart (shown in fig. 10).</p> <div style="text-align: right;"> <p>Playback frequency response chart</p>  <p>Fig. 10</p> </div>
<p>E Playback gain</p> <p>Condition:</p> <ul style="list-style-type: none"> • Playback mode • Tape selector ... Normal position <p>Equipment:</p> <ul style="list-style-type: none"> • VTVM • Oscilloscope • Test tape... QZZCFM 	<p>1. Test equipment connection is shown in fig. 4.</p> <p>2. Playback standard recording level portion on test tape (QZZCFM 315Hz), and using VTVM measure the output level at LINE OUT.</p> <p>3. Make measurement for both channels.</p> <div style="text-align: center; border: 1px solid black; padding: 5px;"> <p>Standard value: 0.4V ± 1dB [around 0.42V: at test points TP5 (L-CH) and TP6 (R-CH)]</p> </div> <p>Adjustment</p> <ol style="list-style-type: none"> If measured value is not within standard, adjust VR1 (L-CH), VR2 (R-CH) (See fig. 2 on page 3). After adjustment, check "Playback frequency response" again.
<p>F Erase current</p> <p>Condition:</p> <ul style="list-style-type: none"> • Record mode • Tape selector ... Metal position <p>Equipment:</p> <ul style="list-style-type: none"> • VTVM • Oscilloscope 	<p>1. Test equipment connection is shown in fig. 11.</p> <p>2. Press the record and pause buttons.</p> <p>3. Set the tape selector to metal position.</p> <p>4. Read voltage on VTVM and calculate erase current by following formula:</p> $\text{Erase current (A)} = \frac{\text{Voltage across both ends of R101}}{1 (\Omega)}$ <div style="text-align: center; border: 1px solid black; padding: 5px;"> <p>Standard value: 160⁺¹⁰₋₂₀ mA (Metal position)</p> </div> <p>5. If measured value is not within standard, adjust as follows.</p> <p>Adjustment</p> <ol style="list-style-type: none"> Open the point (A) and short the point (B) on the main circuit board in the wiring connection diagram (See page 8). Make measurement for erase current. Make sure that the measured value is within the erase current of 140mA to 170mA. If it is beyond the value, carry out the following adjustments: <ul style="list-style-type: none"> If the erase current is less than 140mA, short the point (A). If the erase current is more than 170mA, open the points (A) and (B). <div style="text-align: right;">  <p>Fig. 11</p> </div>
<p>G Overall frequency response</p> <p>Condition:</p> <ul style="list-style-type: none"> • Record/playback mode • Tape selector ... Normal position ... CrO₂ position ... Metal position • Input level controls ... MAX 	<p>Note 1: Before measuring and adjusting, make sure of the playback frequency response (For the method of measurement, please refer to the playback frequency response).</p> <p>Note 2: Test tape QZZCRA to be supplied after July 1980 has higher recording sensitivity in the middle and high frequency range.</p> <div style="text-align: right;"> <p>Overall frequency response chart (Normal)</p>  <p>Fig. 12</p> </div>



ITEM

MEASUREMENT & ADJUSTMENT

ITEM

Equipment:

- VTVM • AF oscillator
- ATT • Oscilloscope
- Resistor (600Ω)
- Test tape (reference blank tape)
 - ... QZZCRA for Normal
 - ... QZZCRX for CrO₂
 - ... QZZCRZ for Metal

-  This chart indicates the standard values for the new type of QZZCRA when in use.
 -  This chart indicates the standard values for the former type of QZZCRA when in use.
- The new type of QZZCRA is marked as shown in fig. 13.

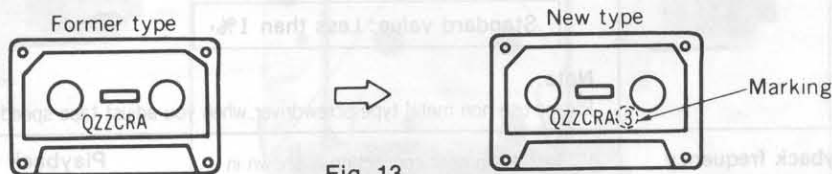

Fig. 13

Overall frequency response adjustment by recording bias current

Note 1:

On RS-M205, overall frequency response is adjusted with tape selector set at Normal.

Note 2:

Recording equalizer is fixed.

1. Make connections as shown in fig. 14.
2. Input a 1 kHz, -24 dB signal through LINE IN. Place the set in record mode.
3. Fine adjust the attenuator to obtain 0.4 V LINE OUT output.
 - Make sure that the input signal level is -24 ± 4 dB with 0.4 V output voltage.

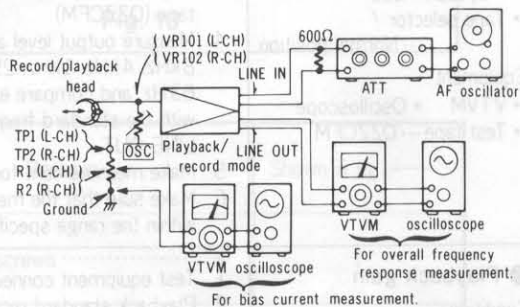

Fig. 14

4. Set the tape selector to Normal, and load the test tape (QZZCRA).
5. Adjust the attenuator to reduce the input signal level by 20 dB.
6. Adjust the AF oscillator to generate 50 Hz, 100 Hz, 200 Hz, 500 Hz, 1 kHz, 4 kHz, 8 kHz and 10 kHz signals, and record these signals on the test tape.
7. Playback the signals recorded in step 6, and check if the frequency response curve is within the limits shown in the overall frequency response chart for normal tapes (fig. 12). (If the curve is within the charted specifications, proceed to steps 8, 9 and 10.) If the curve is not within the charted specifications, adjust as follows;

Adjustment (A):

When the curve exceeds the overall frequency response chart specifications (fig. 12) as shown in fig. 15.

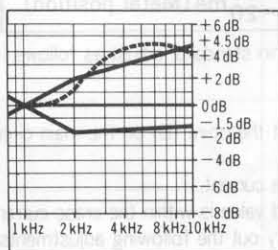

Fig. 15

- 1) Increase bias current by turning VR101 (L-CH) and VR102 (R-CH). (See fig. 2 on page 3.)
- 2) Repeat steps 6 and 7 to confirm. (Proceed to steps 8, 9 and 10 if the curve is now within the charted specifications in fig. 12.)
- 3) If the curve still exceeds the specifications (fig. 12), increase bias current further and repeat steps 6 and 7.

Adjustment (B):

When the curve falls below the overall frequency response chart specifications (fig. 12) as shown in fig. 16.

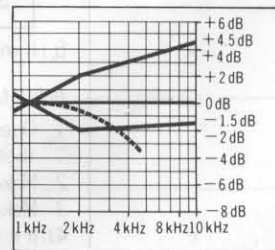

Fig. 16

- 1) Reduce bias current by turning VR101 (L-CH) and VR102 (R-CH).
- 2) Repeat steps 6 and 7 to confirm. (Proceed to steps 8, 9 and 10 if the curve is now within the charted specifications in fig. 12.)
- 3) If the curve still falls below the charted specifications (fig. 12), reduce bias current further and repeat steps 6 and 7.

ITEM SCHEMATIC DIAG MEASUREMENT & ADJUSTMENT



- Switch the tape selector to CrO₂, change test tape to QZZCRX, and record 50Hz, 100Hz, 200Hz, 500Hz, 1kHz, 4kHz, 8kHz, 10kHz and 12.5kHz signals. Then, playback the signals and check if the curve is within the limits shown in the overall frequency response chart for CrO₂ tapes (fig. 17).
- Switch the tape selector to Metal, change test tape to QZZCRZ, and record 50Hz, 100Hz, 200Hz, 500Hz, 1kHz, 4kHz, 8kHz, 10kHz and 12.5kHz signals. Then, playback the signals and check if the curve is within the limits shown in the overall frequency response chart for metal tapes (fig. 17).
- Confirm that bias currents are approximately as follows when the tape selector is set at different positions.

Overall frequency response chart (CrO₂, Metal)

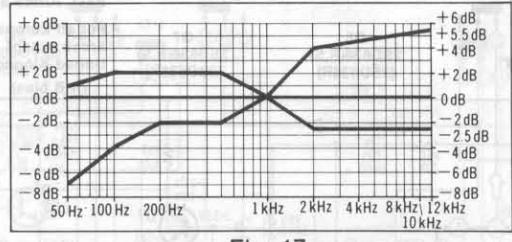

Fig. 17

- Read voltage on VTVM and calculate bias current by following formula:

$$\text{Bias current (A)} = \frac{\text{Value read on VTVM (V)}}{10 (\Omega)}$$

around 410μA (Normal position)
 around 545μA (CrO₂ position)
 around 800μA (Metal position) } : measured at TP1 (L-CH) and TP2 (R-CH)

Overall gain

- Condition:
- Record/playback mode
 - Input level controls... MAX
 - Standard input level:
 MIC - 72 ± 4 dB
 LINE IN ... - 24 ± 4 dB
- Equipment:
- VTVM
 - AF oscillator
 - ATT
 - Oscilloscope
 - Resistor (600Ω)
 - Test tape (reference blank tape) ... QZZCRA for Normal

- Test equipment connection is shown in fig. 18.
- Place UNIT into record mode, and tape selector to normal position.
- Supply 1kHz signal (-24 dB) from AF oscillator, through ATT to LINE IN.
- Adjust ATT until monitor level at LINE OUT becomes 0.4V.
- Using test tape, make recording.
- Playback recorded tape, and make sure the value at LINE OUT on VTVM becomes 0.4V.
- If measured value is not 0.4V, adjust VR5 (L-CH), VR6 (R-CH) (See fig. 2 on page 3).
- Repeat from step (2).

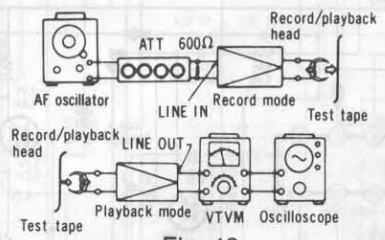

Fig. 18

Level meter

- Condition:
- Record mode
 - Input level control... MAX
- Equipment:
- VTVM
 - AF oscillator
 - ATT
 - Oscilloscope
 - Resistor (600Ω)

- Test equipment connection is shown in fig. 19.
- Supply 1kHz signal (-24 dB) to the LINE IN then press the record button.
- Adjust the ATT so that the output level at LINE OUT becomes 0.4V (The input level at this condition is termed the standard input level).
- At this time, confirm that the level meter reading is within a range of -1.5 dB to +1.5 dB (shown in fig. 20). (Confirm this for both for L and R channels.)

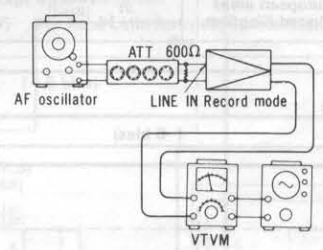

Fig. 19

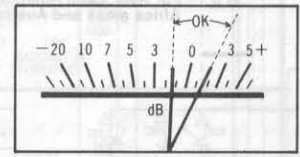

Fig. 20

Dolby NR circuit

- Condition:
- Record mode
 - Dolby NR switch... IN/OUT
 - Input level controls... MAX
- Equipment:
- VTVM
 - AF oscillator
 - ATT
 - Oscilloscope
 - Resistor (600Ω)

- Test equipment connection is shown in fig. 21.
- Place UNIT into record mode, set the Dolby NR switch to OUT position and supply to LINE IN to obtain -34.5 dB at TP5 (L-CH), TP6 (R-CH) (frequency 5 kHz).
- Confirm that the value at IN position is 8 (±2.5) dB greater than the value at OUT position of Dolby NR switch.

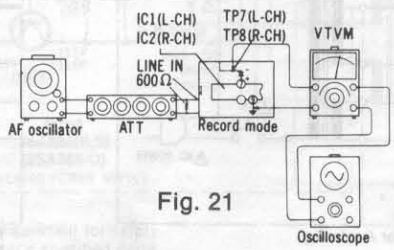
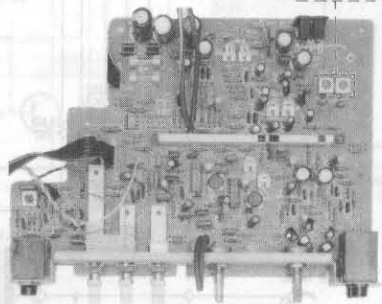
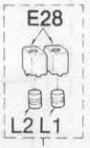
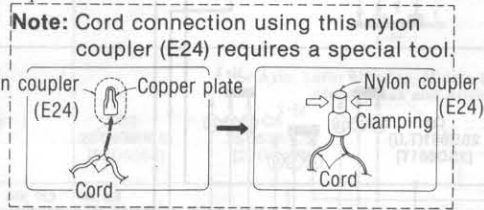
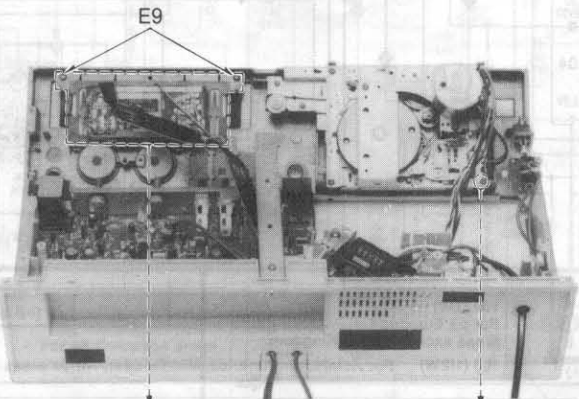
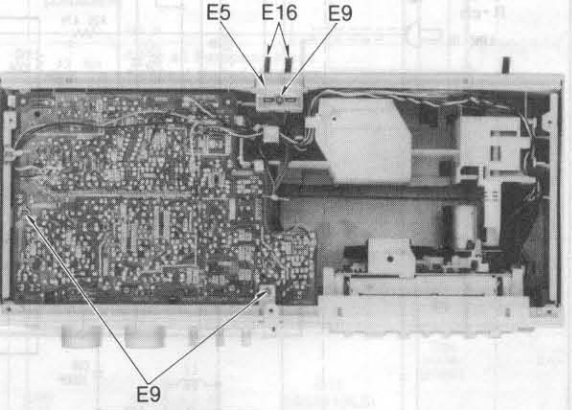
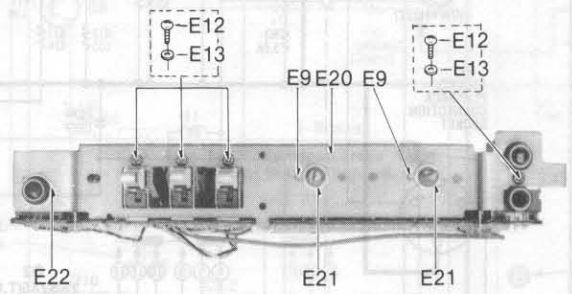
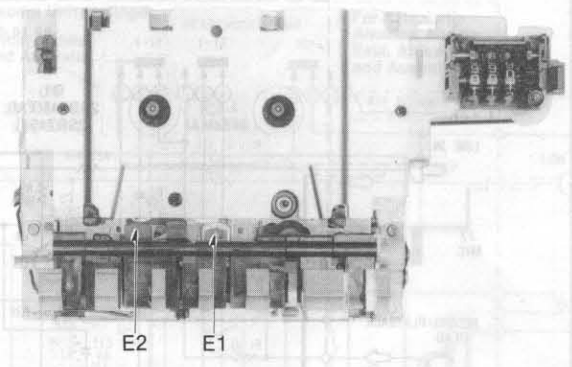
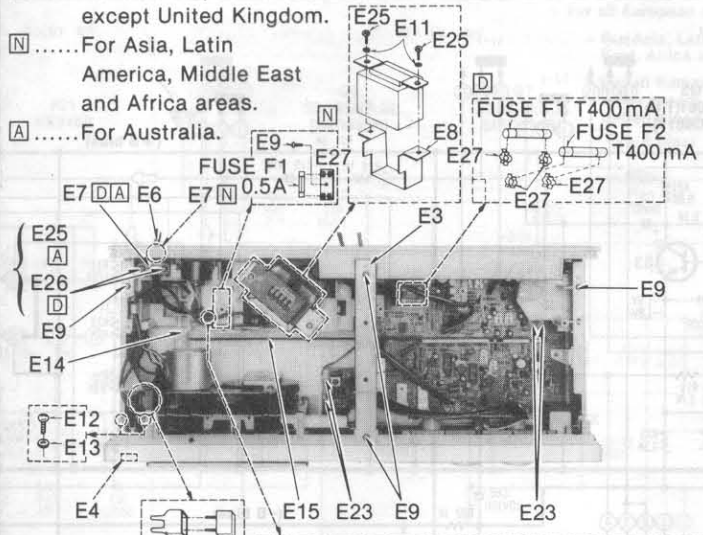

Fig. 21

ELECTRICAL PARTS LOCATION

NOTES:

-For all European areas except United Kingdom.
- △For Asia, Latin America, Middle East and Africa areas.
- ⓂFor Australia.



REPLACEMENT PARTS LIST

Important safety notice
 Components identified by △ mark have special characteristics important for safety.
 When replacing any of these components, use only manufacturer's specified parts.

Ref. No.	Part No.	Part Name & Description
ELECTRICAL PARTS		
E1	QWY4122Z	Record/Playback Head
E2	QWY2138Z	Erase Head
E3	QMA4061	Center Angle
E4	QGO1798	Push Button (for Power ON/OFF)
E5	QKJ0437	Cord Clamper (for Pin Cords)
	"Silver Type"	"
	QKJ0437K	"
	"Black Type"	"
E6	Ⓜ △ SJA88	AC Power Cord
	*For all European areas except United Kingdom.	
	△ RJA52ZB-K	"
	*For Asia, Latin America, Middle East and Africa areas.	
	△ QFC1208M	"
	*For Australia.	
E7	Ⓜ △ QTD1164	Cord Clamper
	*For all European areas and Australia except United Kingdom.	

Ref. No.	Part No.	Part Name & Description
	Ⓜ QTD1129	Cord Bushing
	*For Asia, Latin America, Middle East and Africa areas.	
E8	QTS1531	Shield Plate (for AC Power Transformer)
E9	XTN3+10B	Tapping Screw Ⓜ3×10
E10	QJT0015	Lug Terminal
E11	XWG3	Washer 3φ
E12	XSN3+6S	Screw Ⓜ3×6
E13	XWA3B	Washer 3φ
E14	QML3711	Recording Lever
E15	QBS1132	Recording Wire
E16	QFC2135	Pin Cord
E17	QSL1115RNM	Level Meter
E18	QKJ0464	Meter Holder
E19	XAMQ46P100N	Pilot Lamp
E20	QMA4060	Volume Angle
E21	QNQ1004	Nut 8φ
E22	QNO1070	Nut 12φ
E23	QJT1041	Check Pin
E24	△ QJT1079	Nylon Coupler
E25	XTN3+12B	Tapping Screw Ⓜ3×12
E26	Ⓜ XTN3+16B	Tapping Screw Ⓜ3×16
	*For all European areas except United Kingdom.	

Ref. No.	Part No.	Part Name & Description
E27	Ⓜ △ QTF1054	Fuse Holder
	*For all European areas except United Kingdom.	
	Ⓜ △ QTF1032	"
	*For Asia, Latin America, Middle East and Africa areas.	
E28	QTS1532	Shield Plate (for L1 and L2)
E29	Ⓜ △ QCR0011	Spark Killer
	*For all European areas except United Kingdom.	
E30	Ⓜ QTW1195	Spark Killer Cover
	*For all European areas except United Kingdom.	

DOLBY NR

REC EQ AMP

* For all European areas except United Kingdom.

* For Asia, Latin America, Middle East, Africa areas and Australia.

* For Asia, Latin America, Middle East, Africa areas and Australia.

* For all European areas except United Kingdom. (+ B bias)

* For all European areas except United Kingdom.

* For Asia, Latin America, Middle East, Africa areas and Australia.

* For all European areas except United Kingdom.

* For all European areas except United Kingdom.

* For Asia, Latin America, Middle East, Africa areas and Australia.

* For Australia.

* For Asia, Latin America, Middle East and Africa areas.

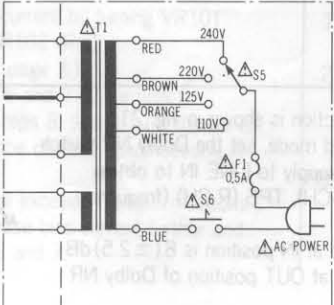
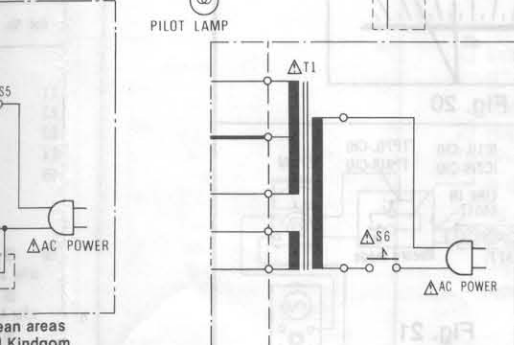
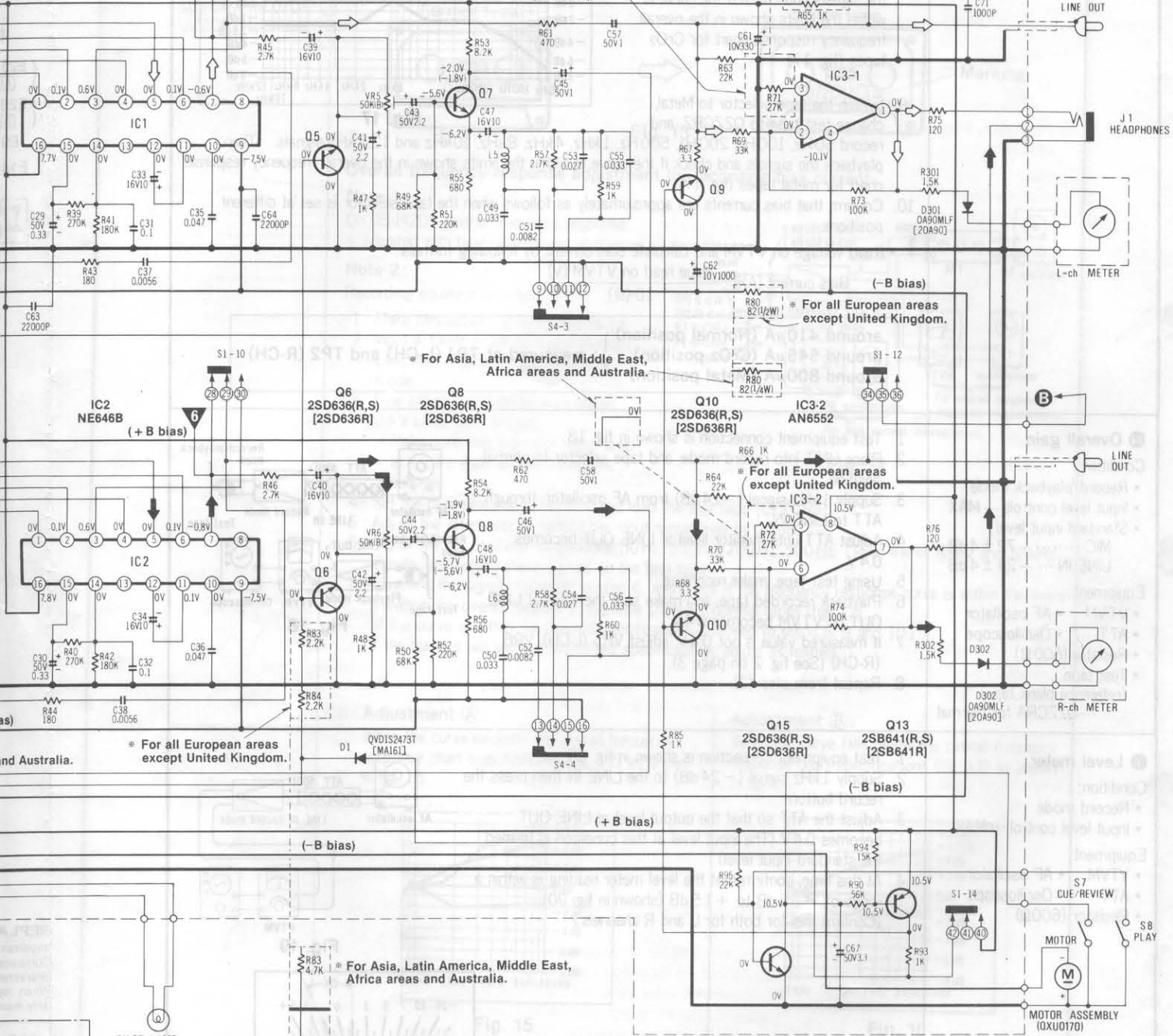

SCHEMATIC DIAGRAM

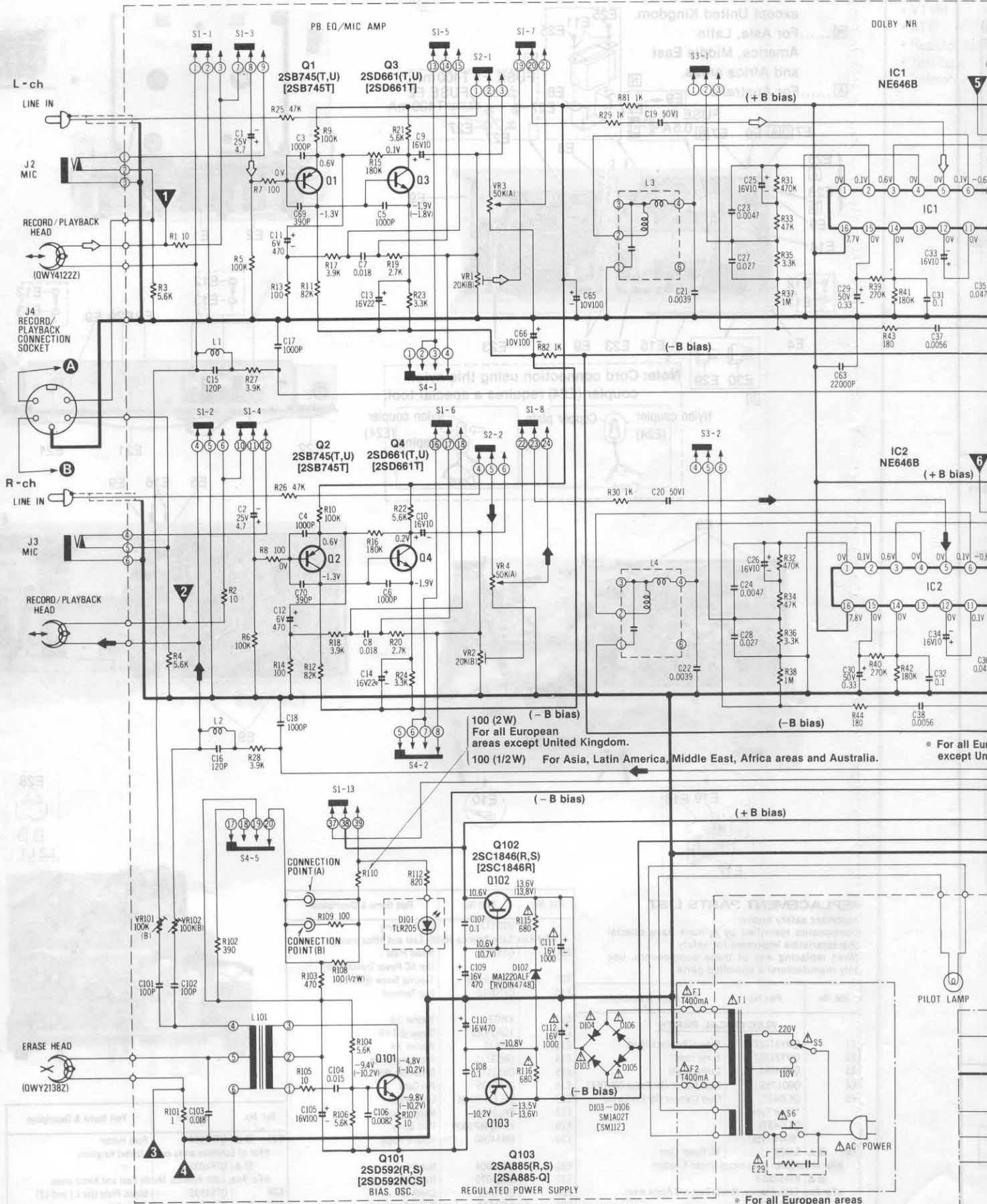

• Important safety notice
 Components identified by Δ mark have special characteristics important for safety.
 When replacing any of these components, use only manufacturer's specified parts.

* For all European areas except United Kingdom

* For A

- NOTE:**
- S1-1—S1-14.....Record/Playback select switch (shown in playback position).
 - S2-1—S1-2.....Input select switch (shown in LINE IN position).
 - S3-1—S3-2.....Dolby IN/OUT select switch (shown in OUT position).
 - S4-1—S4-5.....Tape select switch (shown in normal position).
 - S5.....AC Power voltage select switch.
 - * For all European areas except United Kingdom.
 - * For Asia, Latin America, Middle East and Africa areas.
 - S6.....Power ON/OFF switch (shown in OFF position).
 - S7.....Cue/Review muting switch (shown in off position).
 - S8.....Playback muting switch (shown in off position).
 - VR1, 2.....Playback gain adjustment VR.
 - VR3, 4.....Input level controls.
 - VR5, 6.....Recording gain adjustment VR.
 - VR101, 102.....Bias current adjustment VR.
 - Connection points (A) and (B).....For erase current adjustment.
 - Resistance are in ohms (Ω), 1/4 watt unless specified otherwise.
 - K = 1,000 Ω , M = 1,000K Ω .
 - Capacity are in microfarads (μ F) unless specified otherwise.
 - P = Pico-farads.
 - The mark (∇) shows test point. e.g. ∇ = Test point 1.
 - (\rightarrow) this arrow indicates the flow of the playback signal.
 - (\leftarrow) this arrow indicates the flow of the recording signal.
 - All voltage values shown in circuitry are under no signal condition and record mode with volume control at minimum position.
 - For measurement, use VTVM.
 - However, the voltage in playback mode is indicated in () when it differs from that in record mode.
 - Described in the schematic diagram are two types of numbers; the supply parts number and production parts number for transistors and diodes. One type of number is used for supply parts number and production parts number when they are identical.

e.g. Q1
 2SB745(T,U) ← Production parts number
 [2SB745T] ← Supply parts number
 D1
 QVD1S2473T ← Production parts number
 [MA161] ← Supply parts number

The supply parts number is described alone in the replacement parts list.

EQUIVALENT CIRCUIT

IC3-1, 3-2 AN6552

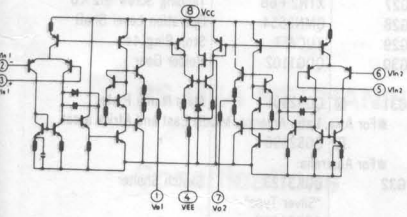

TRANSISTORS (SIDE VIEW)



IC1, 2 NE646B

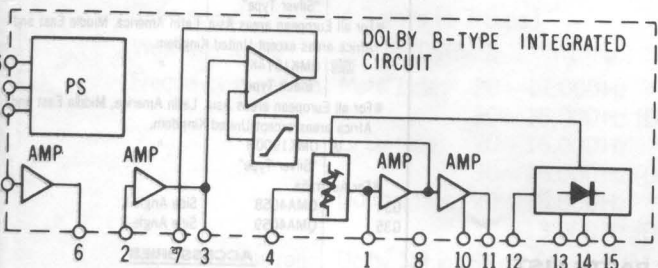

SPECIFICATIONS • Input level controls...MAX.

Playback S/N ratio Test tape ... QZZCFM	Greater than 45 dB (without NAB filter)
Overall distortion Test tape ... QZZCRA for Normal ... QZZCRX for CrO ₂ ... QZZCRZ for Metal	Less than 4%
Overall S/N ratio Test tape ... QZZCRA	Greater than 43 dB

- NOTES: RESISTORS**
- ERD...Carbon
 - ERG...Metal-oxide
 - ERS...Metal-oxide
 - ERO...Metal-film
 - ERX...Metal-film
 - ERQ...Fuse type metallic
 - ERC...Solid
 - ERF...Cement
- CAPACITORS**
- ECBA...Ceramic
 - ECGD...Ceramic
 - ECK...Ceramic
 - ECCD...Ceramic
 - ECFO...Ceramic
 - ECQM...Polyester film
 - ECQE...Polyester film
 - ECQF...Polypropylene
 - ECED...Electrolytic
 - ECEDN...Non polar electrolytic
 - ECQS...Polystyrene
 - ECSD...Tantalum
 - QCS...Tantalum

REPLACEMENT PARTS LIST

Important safety notice
 Components identified by Δ mark have special characteristics important for safety.
 When replacing any of these components, use only manufacturer's specified parts.

Ref. No.	Part No.	Ref. No.	Part No.	Ref. No.	Part No.	Ref. No.	Part No.
RESISTORS				TRANSISTORS			
R1, 2	ERD25FJ100	R110	ERG2ANJ101	C23, 24	ECQM1H472JZ	C105	ECEA1ES101
R3, 4	ERD25FJ562	*For all European areas except United Kingdom.		C25, 26	ECEA1HS100	C106	ECFDD822KVY
R5, 6	ERD25TJ104	[NA]	ERD50FJ101	C27, 28	ECQM1H273JZ	C107, 108	ECQV05104JZ
R7, 8	ERD25FJ101	*For Asia, Latin America, Middle East, Africa areas and Australia.		C29, 30	ECEA50MR33R	C109, 110	ECEA1CS471
R9, 10	ERD25TJ104	R112	ERD25FJ821	C31, 32	ECQV05104JZ	C111, 112	Δ ECEA1CS102
R11, 12	ERD25TJ823	R115, 116	Δ ERD25FJ681	C33, 34	ECEA1HS100	TRANSISTORS	
R13, 14	ERD25FJ101	R301, 302	ERD25FJ152	C35, 36	ECFDD473KXY	Q1, 2	2SB745T
R15, 16	ERD25TJ184	VARIABLE RESISTORS		C37, 38	ECQM1H562JZ	Q3, 4	2SD661T
R17, 18	ERD25FJ392	VR1, 2	EVNM4AA00B24	C39, 40	ECEA1HS100	Q5, 6, 7, 8, 9, 10	2SD636R
R19, 20	ERD25FJ272	VR3, 4	QVH3AA067A54	C41, 42, 43, 44	ECEA50Z2R2	Q13	2SB641R
R21, 22	ERD25FJ562	VR5, 6	EVNM4AA00B54	C45, 46	ECEA50Z1	Q15	2SD636R
R23, 24	ERD25FJ332	VR101, 102	EVNM4AA00B15	C47, 48	ECEA1HS100	Q101	2SD592NCS
R25, 26	ERD25TJ473	CAPACITORS		C49, 50	ECEA1H333JZ	Q102	2SC1846R
R27, 28	ERD25FJ392	C1, 2	ECEA25M4R7R	C51, 52	ECFDD822KVY	Q103	2SA885Q
R29, 30	ERD25FJ102	C3, 4, 5, 6	ECFDD102KVY	C53, 54	ECFDD273KXY	DIODES	
R31, 32	ERD25TJ474	C7, 8	ECQM1H183KZ	C55, 56	ECFDD333KXY	D1	MA161
R33, 34	ERD25TJ473	C9, 10	ECEA1HS100	C57, 58	ECEA1HN010	D101	TLR205
R35, 36	ERD25FJ332	C11, 12	ECEAQAS471	C61	ECEA1AS331	D102	RVD1N4748
R37, 38	ERD25TJ105	C13, 14	ECEA1ES220	C62	ECEA1AS102	D103, 104, 105, 106	Δ SM112
R39, 40	ERD25TJ274	C15, 16	ECKD2H121KBL	C63, 64	ECKD1H223ZF	D301, 302	20A90
R41, 42	ERD25TJ184	C17, 18	ECFDD102KVY	C65, 66	ECEA1AS101	INTEGRATED CIRCUITS	
R43, 44	ERD25FJ181	C19, 20	ECEA1HN010	C67	ECEA50Z3R3	IC1, 2	NE646B
R45, 46	ERD25FJ272	C21, 22	ECFDD392KVY	C69, 70	ECKD1H391KB	IC3	AN6552
R47, 48	ERD25FJ102	SWITCHES		C71	ECKD1H102MD		
R49, 50	ERD25TJ683	S1	QSSE203	C101, 102	ECQD1H121KD		
R51, 52	ERD25TJ224	S2, 3	QES1544	C103	ECQP1183JZ		
R53, 54	ERD25FJ822	S4	QES1490	C104	ECFDD153KXY		
R55, 56	ERD25FJ681	S5	Δ QSR1409H				
R57, 58	ERD25FJ272	*For all European areas except United Kingdom.					
R59, 60	ERD25FJ102	[NA]	QSR1407H				
R61, 62	ERD25FJ471	*For Asia, Latin America, Middle East and Africa areas.					
R63, 64	ERD25TJ223	S6	Δ QSW1117AS				
R65, 66	ERD25FJ102	S7, 8	QSB0251i				
R67, 68	ERD25FJ3R3	*For all European areas except United Kingdom.					
R69, 70	ERD25TJ333	[NA]	QSW1117AS				
R71, 72	Δ ERD25TJ273	*For Asia, Latin America, Middle East and Africa areas and Australia.					
R73, 74	ERD25TJ104	TRANSFORMER					
R75, 76	ERD25FJ121	T1	Δ QLPD52EKC	AC Power Transformer			
R79, 80	Δ ERG12ANJ820	*For all European areas except United Kingdom.					
*For all European areas except United Kingdom.		[NA]	QLPN64EKC				
*For Asia, Latin America, Middle East, Africa areas and Australia.		[NA]	QLPA61EKC				
R81, 82	ERD25FJ102	*For Australia.					
R83	Δ ERD25FJ222	COILS					
*For all European areas except United Kingdom.		L1, 2	QLQX0343K	Bias Trap Coil			
*For Asia, Latin America, Middle East, Africa areas and Australia.		L3, 4	SLM1Z19	MPX Filter			
R84	Δ ERD25FJ222	L5, 6	QLQX0332K	Peaking Coil			
*For all European areas except United Kingdom.		L101	QLB0198K	Bias Oscillation Coil			
R85	ERD25FJ102	FUSES					
R90	ERD25TJ563	F1	Δ XBAQ0007	Fuse (T400mA)			
R93	ERD25FJ102	*For all European areas except United Kingdom.					
R94	ERD25TJ153	[NA]	XBA1E05NR1	Fuse (0.5A)			
R95	ERD25TJ223	*For Asia, Latin America, Middle East and Africa areas.					
R101	ERD25FJ1R0	F2	Δ XBAQ0007	Fuse (T400mA)			
R102	ERD25FJ391	*For all European areas except United Kingdom.					
R103	ERD25FJ471	JACKS					
R104	ERD25FJ562	J1	QJA0249	Headphones Jack			
R105	ERD25FJ100	J2, 3	QJA0257	Microphone Jack			
R106	ERD25FJ562	J4	QJS1954H	Record/Playback Connection Socket (DIN Socket)			
R107	ERD25FJ100						
R108	ERD50FJ101						
R109	ERD25FJ101						

CIRCUIT BOARDS AND WIRING CONNECTION

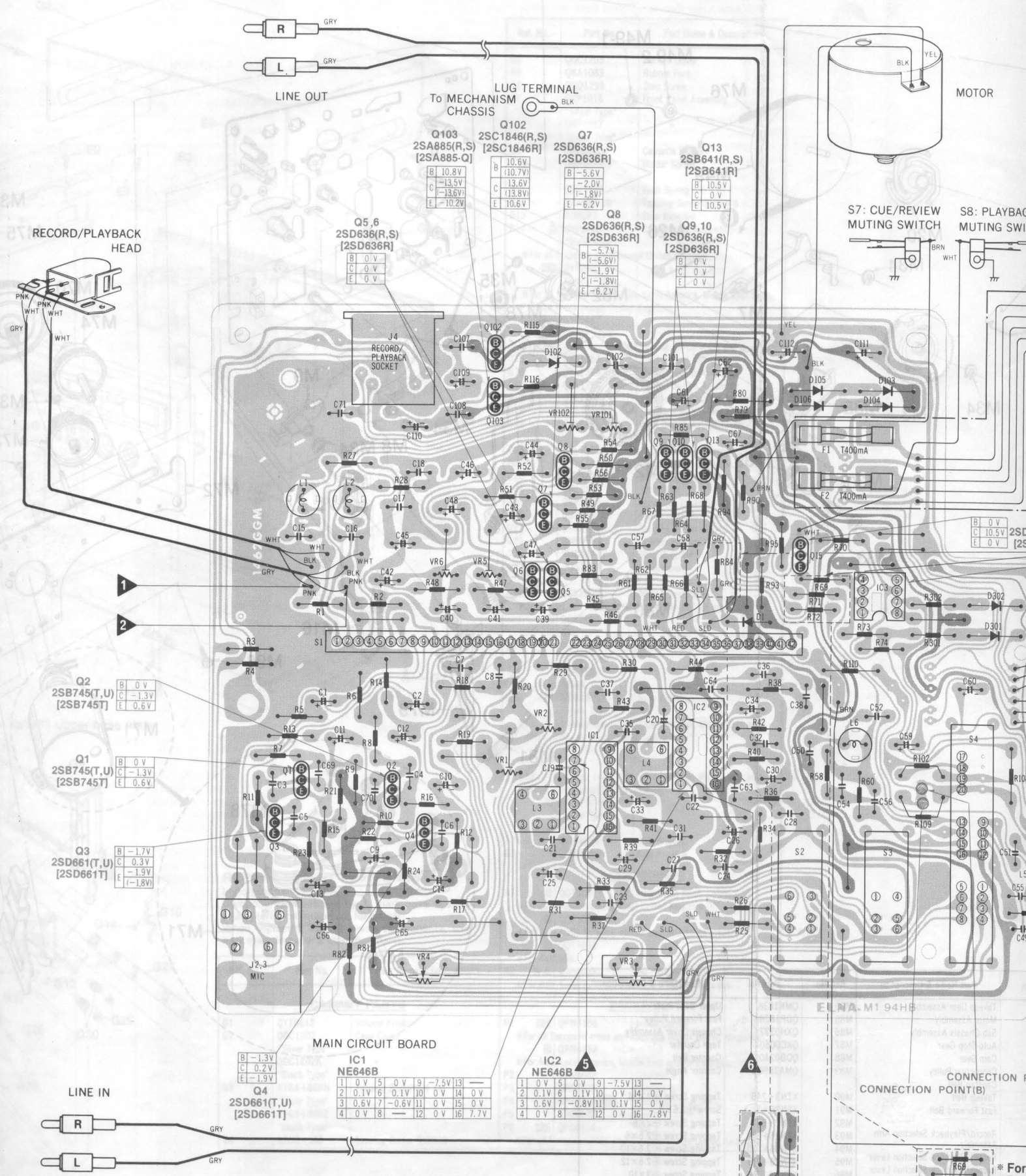

* For Asia, Latin America, Middle East, Africa areas and Australia.

ION MECHANISM PARTS LOCATION

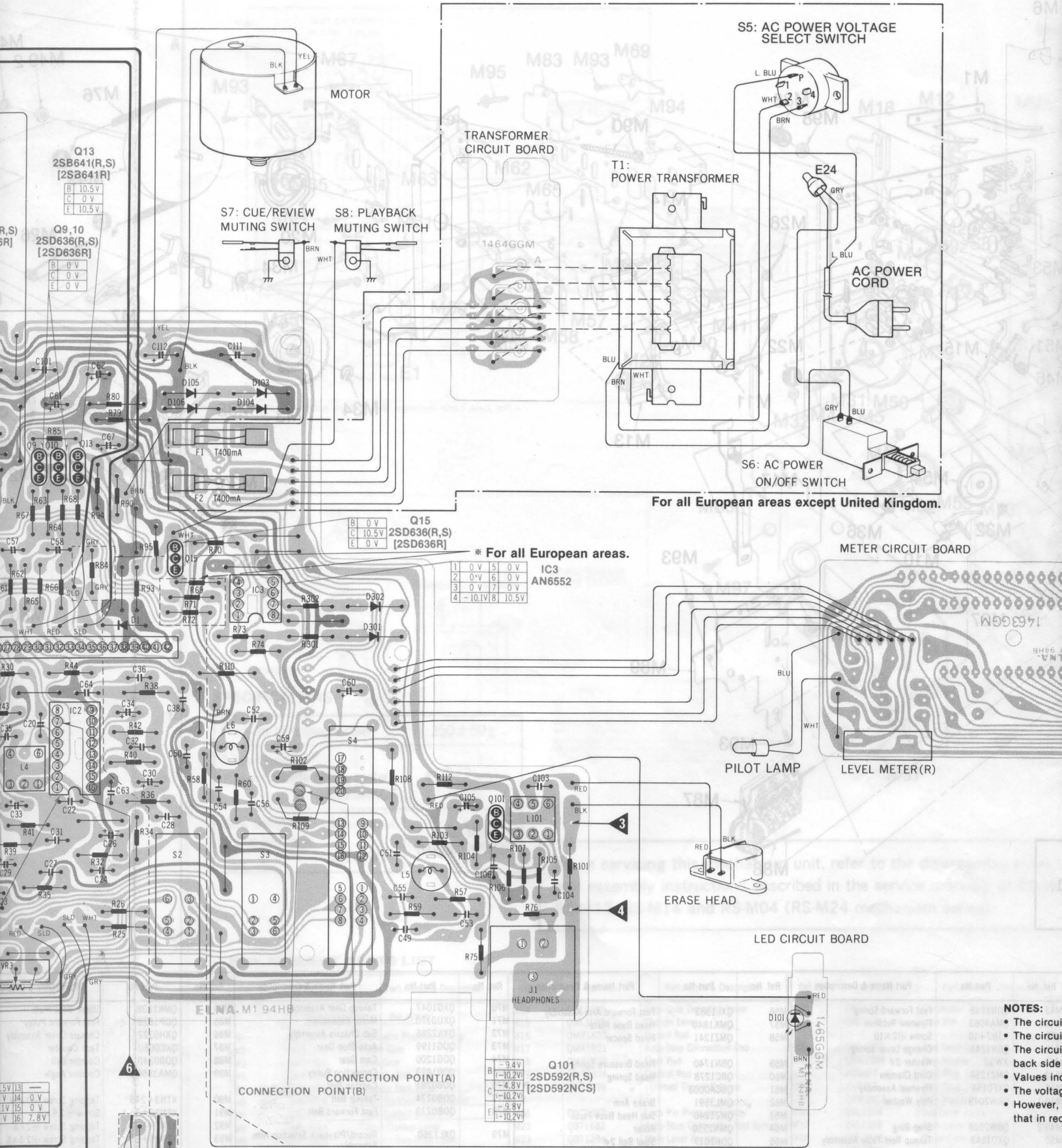

For all European areas except United Kingdom.

* For all European areas.

1	0 V	5	0 V
2	0 V	6	0 V
3	0 V	7	0 V
4	-10.1V	8	10.5V

IC3 AN6552

* For Asia, Latin America, Middle East, Africa areas and Australia.

* For Asia, Latin America, Middle East, Africa areas and Australia.

- NOTES:**
- The circuit board is shown in the back side view.
 - Values in parentheses are for the RS-M204 (RS-M24) model.
 - However, the circuit board is not shown in the back side view.

MECHANISM PARTS LOCATION

5 4 3 2 1

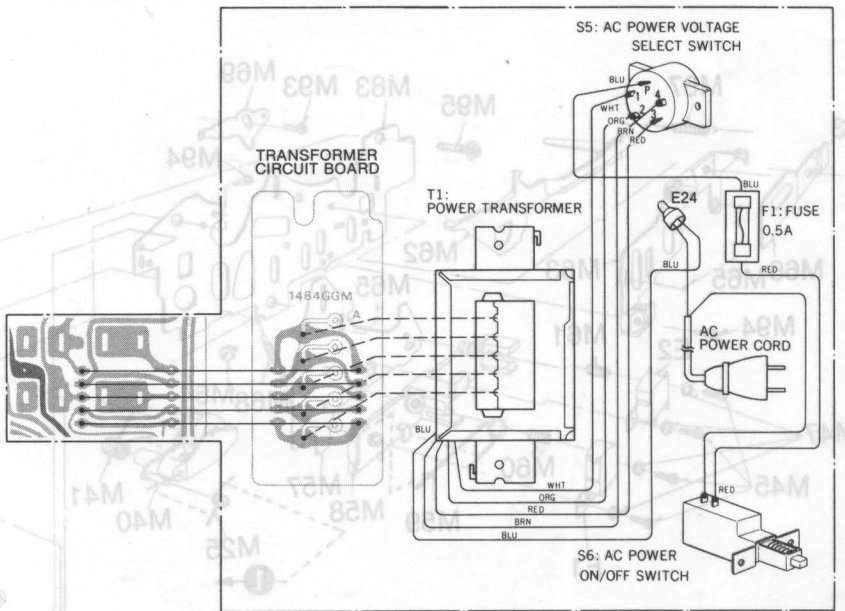
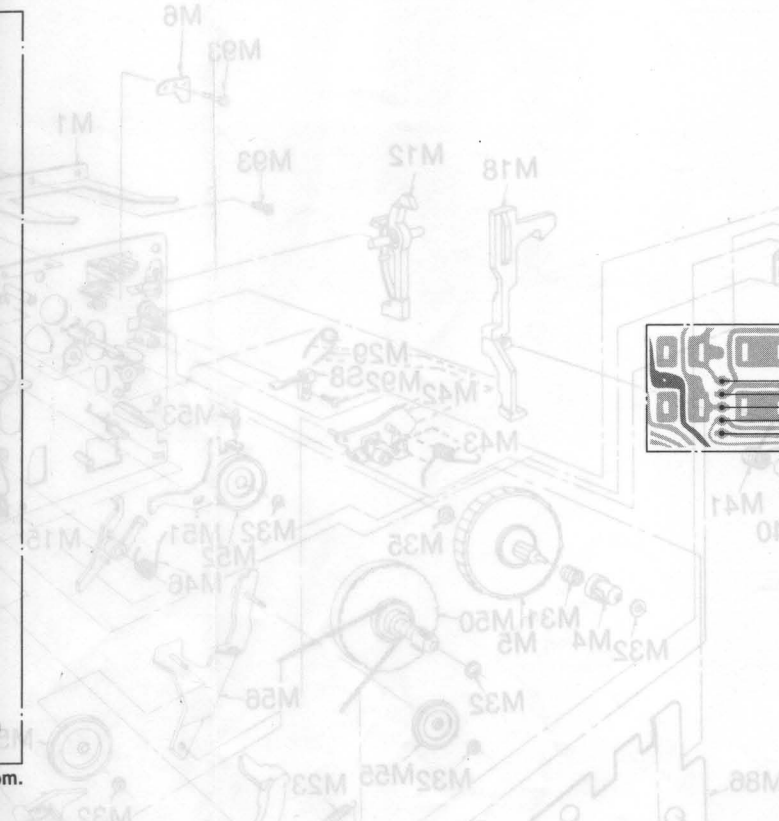

* For Asia, Latin America, Middle East and Africa areas.

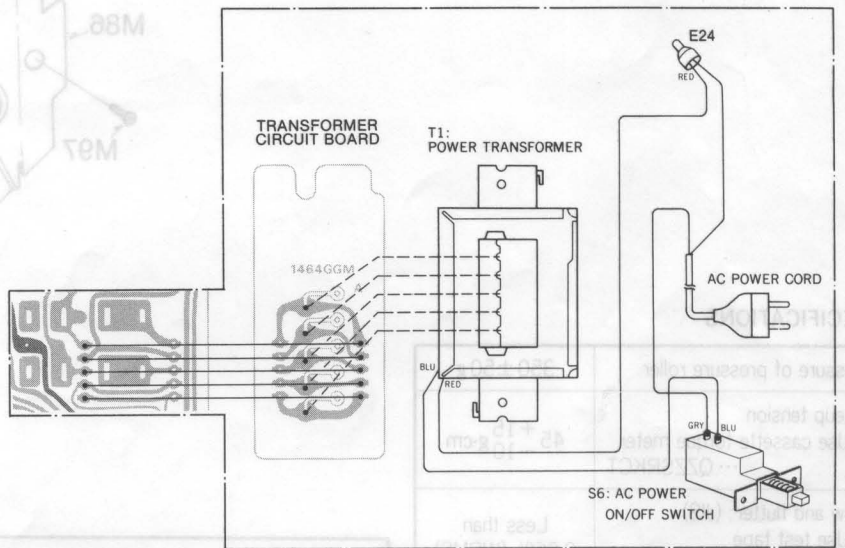
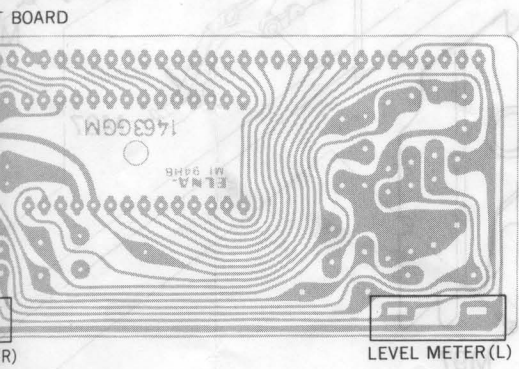

* For Australia

When servicing this mechanism unit, refer to the disassembly notes and assembly instructions described in the service manual of RS-M21, RS-M13, RS-M14 and RS-M04 (RS-M24 mechanism series).

REPLACEMENT PARTS LIST

Part No.	Part Name & Description	Part No.	Part Name & Description	Part No.	Part Name & Description	Part No.	Part Name & Description
Q1	Diode	Q2	Diode	Q3	Diode	Q4	Diode
Q5	Diode	Q6	Diode	Q7	Diode	Q8	Diode
Q9	Diode	Q10	Diode	Q11	Diode	Q12	Diode
Q13	Diode	Q14	Diode	Q15	Diode	Q16	Diode
Q17	Diode	Q18	Diode	Q19	Diode	Q20	Diode
Q21	Diode	Q22	Diode	Q23	Diode	Q24	Diode
Q25	Diode	Q26	Diode	Q27	Diode	Q28	Diode
Q29	Diode	Q30	Diode	Q31	Diode	Q32	Diode
Q33	Diode	Q34	Diode	Q35	Diode	Q36	Diode
Q37	Diode	Q38	Diode	Q39	Diode	Q40	Diode
Q41	Diode	Q42	Diode	Q43	Diode	Q44	Diode
Q45	Diode	Q46	Diode	Q47	Diode	Q48	Diode
Q49	Diode	Q50	Diode	Q51	Diode	Q52	Diode
Q53	Diode	Q54	Diode	Q55	Diode	Q56	Diode
Q57	Diode	Q58	Diode	Q59	Diode	Q60	Diode
Q61	Diode	Q62	Diode	Q63	Diode	Q64	Diode
Q65	Diode	Q66	Diode	Q67	Diode	Q68	Diode
Q69	Diode	Q70	Diode	Q71	Diode	Q72	Diode
Q73	Diode	Q74	Diode	Q75	Diode	Q76	Diode
Q77	Diode	Q78	Diode	Q79	Diode	Q80	Diode
Q81	Diode	Q82	Diode	Q83	Diode	Q84	Diode
Q85	Diode	Q86	Diode	Q87	Diode	Q88	Diode
Q89	Diode	Q90	Diode	Q91	Diode	Q92	Diode
Q93	Diode	Q94	Diode	Q95	Diode	Q96	Diode
Q97	Diode	Q98	Diode	Q99	Diode	Q100	Diode

NOTES:

- The circuit shown in [shaded] on the conductor is +B (bias) circuit.
- The circuit shown in [unshaded] on the conductor is -B (bias) circuit.
- The circuit shown in [dotted] on the conductor side indicates printed circuit on the back side of the printed circuit board.
- Values indicated in [box] are DC voltage between the ground and electrical parts.
- The voltage indicates are measured during record mode.
- However, the voltage in playback mode is indicates in () when it differs from that in record mode.

- Described in the circuit board diagram are two types of numbers; the supply parts number and production parts number for transistors. One type of number is used for supply parts number and production parts number when they are identical. e.g. Q1 { 2SB745(T,U) — Production parts number [2SB745T] — Supply parts number
- The supply parts number is described alone in the replacement parts list.

CIRCUIT BOARDS AND WIRING CONNECTION

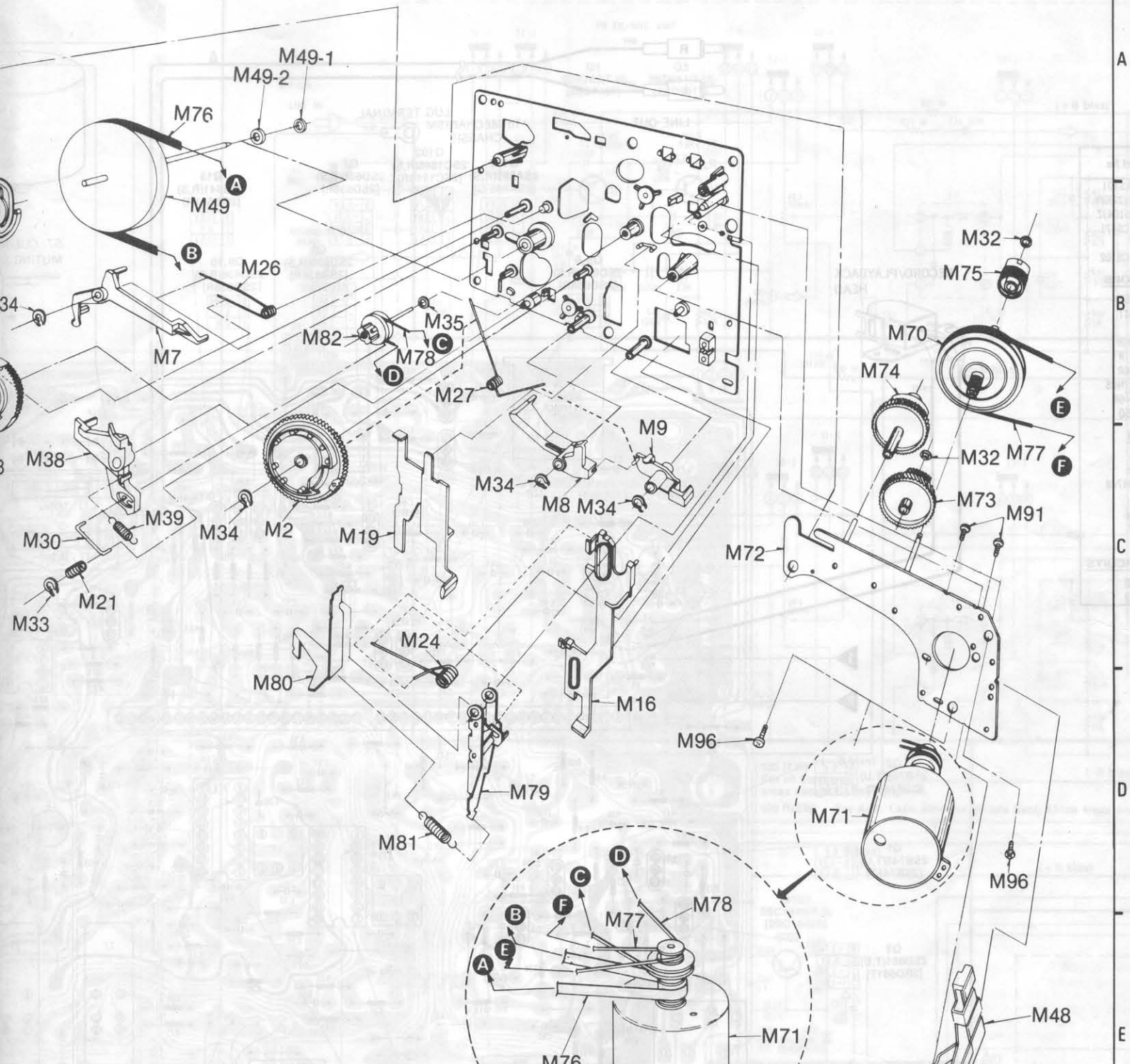

Description	Ref. No.	Part No.	Part Name & Description
	M83	QMK1838	Upper Base Plate
	M85	QDP1828	Fast Forward Pulley
	M86	QXH0327	Chassis Cover Assembly
	M87	QXC0060	Tape Counter
	M88	QDB0240	Counter Belt
	M89	QMA3860	Counter Angle
	M90	XTN3+24B	Tapping Screw $\oplus 3 \times 24$
	M91	XSN26+3	Screw $\oplus 2.6 \times 3$
	M92	XTN2+6B	Tapping Screw $\oplus 2 \times 6$
	M93	XTN26+6B	Tapping Screw $\oplus 2.6 \times 6$
	M94	XTN26+10B	Tapping Screw $\oplus 2.6 \times 10$
	M95	XTN26+12B	Tapping Screw $\oplus 2.6 \times 12$
	M96	XTN3+10B	Tapping Screw $\oplus 3 \times 10$
	M97	XTN26+6BFZ	Tapping Screw $\oplus 2.6 \times 6$
	M98	QBW2085	Poly Washer

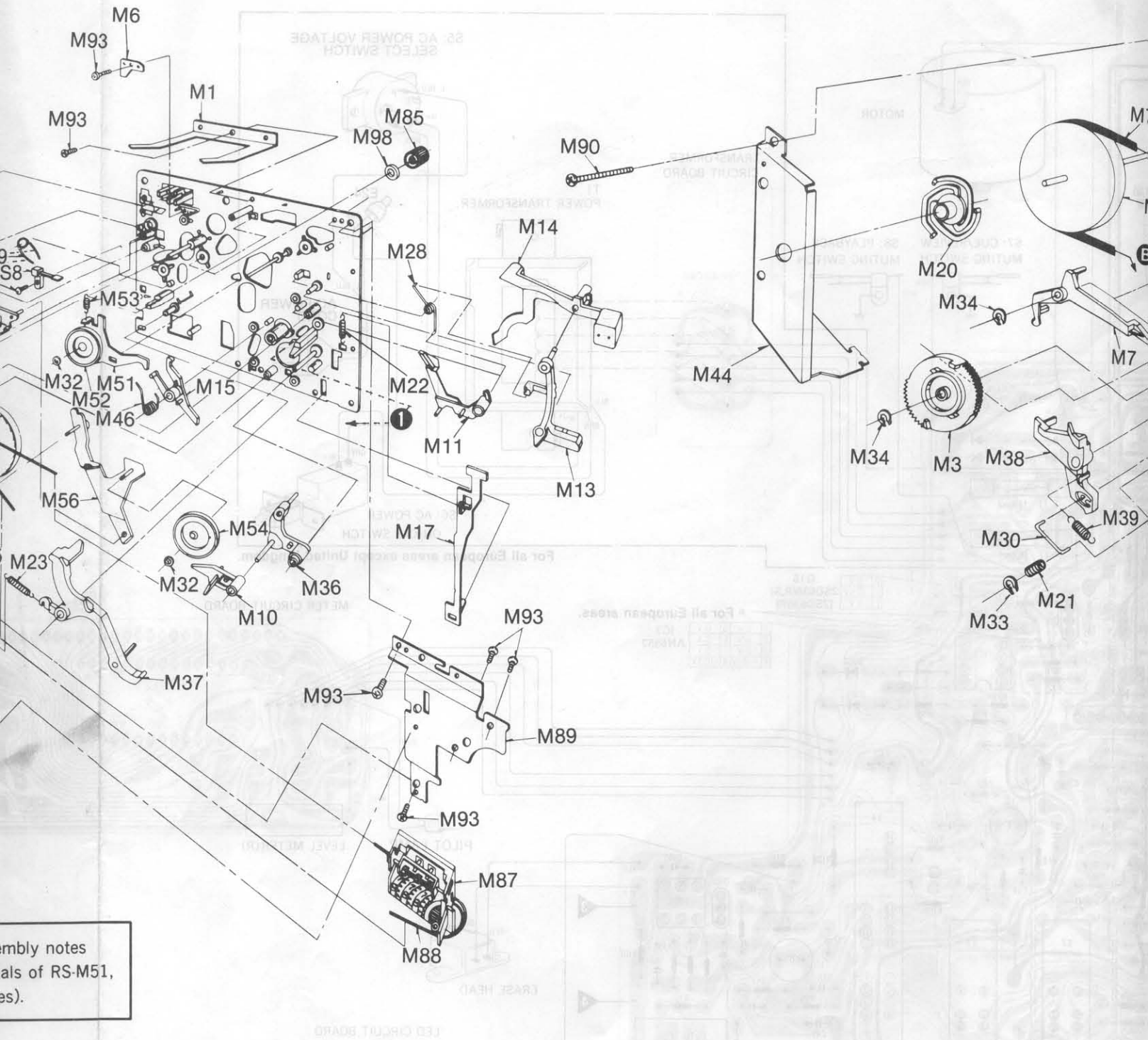

Assembly notes
 Details of RS-M51,
 (es).

Part Name & Description	Ref. No.	Part No.	Part Name & Description	Ref. No.	Part No.	Part Name & Description	Ref. No.	Part No.	Part Name & Description	Ref. No.	Part No.
Spring	M43	QBN1748	Fast Forward Spring	M56	QXL1383	Fast Forward Arm Assembly	M70	QXG1047	Takeup Gear Assembly	M83	QMK1838
	M44	QMA4063	Flywheel Retainer	M57	QMK1840	Head Base Plate	M71	QXU0170	Motor Assembly	M85	QDP1828
	M45	XSN2+10	Screw 2x10	M58	QMZ1241	Head Spacer	M72	QXK2286	Sub Chassis Assembly	M86	QXH0327
Spring	M46	QBN1741	Change Lever Spring				M73	QDG1199	Auto-Stop Gear	M87	QXC0060
	M47	XWG2	Washer 2φ	M59	QBN1740	Head Bressure Spring	M74	QDG1200	Cam Gear	M88	QDB0240
	M48	QMZ1254	Cord Clamp	M60	QBC1278	Head Spring	M75	QDP1823	Connection Pulley	M89	QMA3860
	M49	QXF0164	Flywheel Assembly	M61	QBCA0008	"	M76	QDB0281	Capstan Belt		
	M49-1	QBW2049	Poly Washer	M62	QML3591	Brake Arm	* M77	QDB0274	Takeup Belt	3898	
Assembly				M63	QMZ1240	Sub Head Base Plate	* M78	QDB0273	Fast Forward Belt	3895	
Assembly	M49-2	QBW2026	Snap Ring	M64	QMN2550	Roller				12529	
Lever	M50	QXD1143	Takeup Reel Table Assembly	M65	QDK1017	Steel Ball 2φ	M79	QXL1360	Record/Playback Selection Arm Assembly	M90	XTN3+24B
Spring	M51	QXL1382	Idle Lever Assembly	M66	QBP1873	Head Base Plate Pressure Spring	M80	QML3580	Record/Playback Selection Lever	M91	XSN26+3
Lever Assembly	M52	QX10111	Takeup Idler Assembly	M67	QBT1597	Brake Arm Spring	M81	QBT1895	Record/Playback Selection Lever Spring	M92	XTN2+6B
	M53	QBT1893	Takeup Idler Spring	M68	QBT1892	Head Release Spring	M82	QXP0607	Fast Forward Connection Pulley Assembly	M93	XTN26+6B
Spring	M54	QX10113	Fast Forward Idler Assembly						M94	XTN26+10B	
Lever	M55	QX10112	Rewind Idler Assembly	M69	QMA3858	Head Adjustment Plate			M95	XTN26+12B	
									M96	XTN3+10B	
									M97	XTN26+6BFZ	
									M98	QBW2085	

MECHANISM PARTS LOCATION

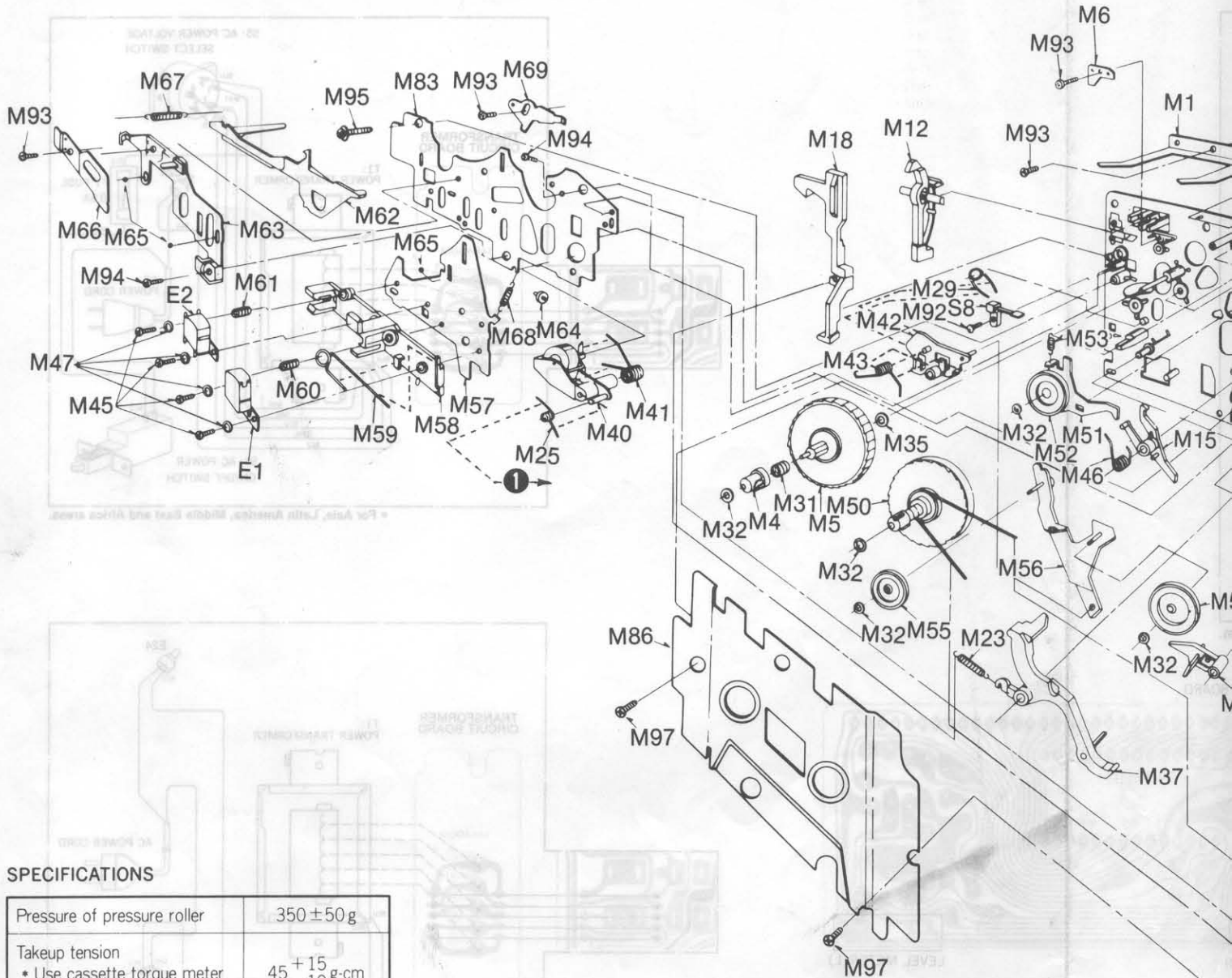

SPECIFICATIONS

Pressure of pressure roller	350 ± 50 g
Takeup tension * Use cassette torque meter ... QZZSRKCT	45 ⁺¹⁵ / ₋₁₀ g·cm
Wow and flutter; (JIS) * Use test tape ... QZZCWAT	Less than 0.06% (WRMS)

When servicing this mechanism unit, refer to the disassembly notes and assembly instructions described in the service manuals of RS-M51, RS-M13, RS-M14 and RS-M04 (RS-M24 mechanism series).

REPLACEMENT PARTS LIST

Ref. No.	Part No.	Part Name & Description	Ref. No.	Part No.	Part Name & Description	Ref. No.	Part No.	Part Name & Description	Ref. No.	Part No.	
MECHANICAL PARTS											
M1	QBP1874	Cassette Pressure Spring	M14	QML3605	Auto-Stop Detection Lever	M29	QBN1747	Connection Spring	M43	QBN1748	
M2	QDG1201	Main Gear	M15	QML3592	Change Lever	M30	QBS1128	Lock Pin	M44	QMA4063	
M3	QDG1202	Sub Gear	M16	QMR1820	Record Rod	M31	QBC1372	Reel Table Spring	M45	XSN2+10	
M4	QMB1336	Supply Reel Table Hub	M17	QMR1821	Auto-Stop Connection Rod	M32	QBW2008	Poly Washer	M46	QBN1741	
M5	QDR1139	Supply Reel Table	M18	QMR1822	Eject Rod	M33	XUB4FT	Stop Ring 4φ	M47	XWG2	
M6	QMF2118	Fast Forward Arm Bracket	M19	QMR1824	Control Rod	M34	XUB3FT	Stop Ring 3φ	M48	QMZ1254	
M7	QML3581	Sub Control Lever	M20	QMZ1239	Flywheel Thrust Retainer	M35	QBW2012	Poly Washer	M49	QXF0164	
M8	QML3583	Main Control Lever	M21	QBC1357	Lock Pin Pressure Spring	M36	QXL1354	Sub Lever Assembly	M49-1	QBW2049	
M9	QML3584	Record Operation Lever	M22	QBT1682	Auto-Stop Connection Rod Spring	M37	QXL1355	Main Lever Assembly	M49-2	QBW2026	
M10	QML3586	Head Base Plate Lift Lever	M23	QBT1894	Main Lever Spring	M38	QML3582	Pause Lock Lever	M50	QXD1143	
M11	QML3594	Auto-Stop Release Arm	M24	QBN1739	Selection Lever Spring	M39	QBT1896	Lever Release Spring	M51	QXL1382	
M12	QML3603	Erase Safety Lever	M25	QBN1742	Pressure Roller Release Spring	M40	QXL1381	Pressure Roller Assembly	M52	QXi0111	
M13	QML3604	Auto-Stop Driving Lever	M26	QBN1744	Sub Gear Spring	M41	QBN1743	Pressure Roller Spring	M53	QBT1893	
			M27	QBN1802	Main Gear Spring	M42	QML3588	Fast Forward Lever	M54	QXi0113	
			M28	QBN1746	Auto-Stop Lever Spring				M55	QXi0112	

CABINET PARTS LOCATION

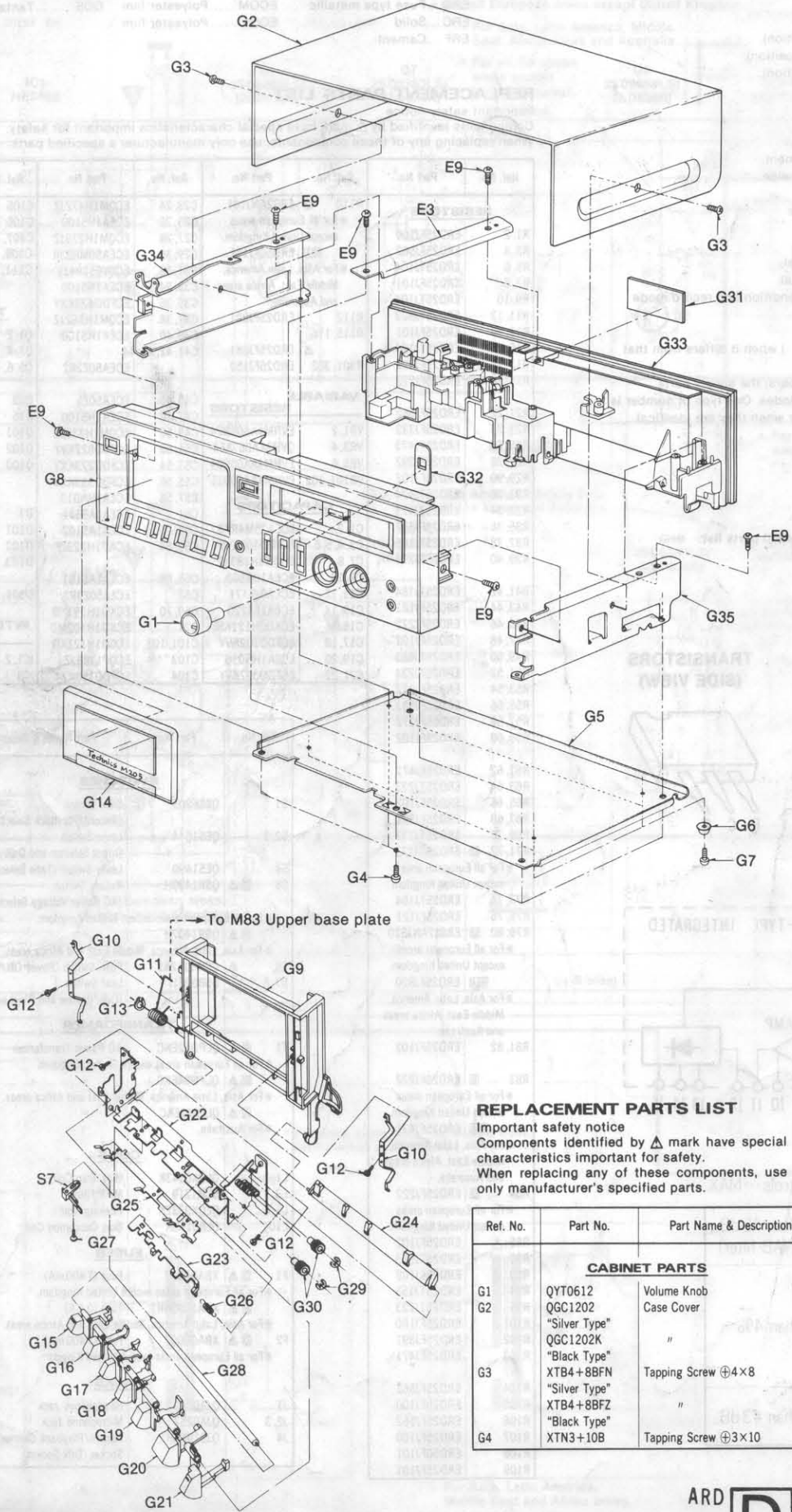

Ref. No.	Part No.	Part Name & Description
G5	QGC1203	Bottom Cover
G6	QKA1083	Rubber Foot
G8	QH01299	Step Screw
G8	QYP1016	Front Panel Assembly
	"Silver Type"	" "
	QYP1017	" "
	"Black Type"	" "
G9	QKF2092K	Cassette Holder
G10	QBP1771	Holder Spring
G11	QBN1749	Eject Spring
G12	XTN26+6B	Tapping Screw $\oplus 2.6 \times 6$
G13	XUB5FT	Stop Ring 5ϕ
G14	QYF0488	Cassette Lid Assembly
	"Silver Type"	" "
*For all European areas except United Kingdom.		
	QYF0489	" "
	"Black Type"	" "
*For all European areas Asia, Latin America, Middle East and Africa areas except United Kingdom.		
	QYF0487	"Silver Type"
*For Asia, Latin America, Middle East, Africa areas and Australia.		
G15	QXL1363	Eject Button Assembly
G16	QXL1364	Record Button Assembly
G17	QXL1365	Rewind Button Assembly
G18	QXL1366	Fast Forward Button Assembly
G19	QXL1367	Playback Button Assembly
G20	QXL1368	Stop Button Assembly
G21	QXL1369	Pause Button Assembly
G22	QXA1044	Operation Button Angle
G23	QMR1823	Obstruction Rod
G24	QML3593	Lock Arm
G25	QBP1875	Operation Lever Spring
G26	QBT1597	Obstruction Rod Spring
G27	XTN2+6B	Tapping Screw $\oplus 2 \times 6$
G28	QMN2554	Operation Lever Shaft
G29	XUC4FT	Stop Ring 4ϕ
G30	QDG1102	Holder Gear
G31	QGS2905	Main Name Plate
*For Asia, Latin America, Middle East and Africa areas.		
	QGS2896	" "
*For Australia.		
G32	Q GK3123	Switch Shelter
	"Silver Type"	" "
	Q GK3123K	" "
	"Black Type"	" "
G33	QMK1914H	Back Chassis
	"Silver Type"	" "
*For all European areas Asia, Latin America, Middle East and Africa areas except United Kingdom.		
	QMK1914K	" "
	"Black Type"	" "
*For all European areas Asia, Latin America, Middle East and Africa areas except United Kingdom.		
	QMK1900H	" "
	"Silver Type"	" "
*For Australia.		
G34	QMA4058	Side Angle-L
G35	QMA4059	Side Angle-R
ACCESSORIES		
A1	QQT3027	Instruction Book
*For all European areas except United Kingdom.		
	QQT3030	" "
*For Asia, Latin America, Middle East and Africa areas.		
	QQT3031	" "
*For Australia.		
A2	QJP0603S	AC Plug Adaptor
*For Asia, Latin America, Middle East and Africa areas.		
PACKINGS		
P1	QPN4156	Inside Carton
*For all European areas and Australia except United Kingdom.		
	QPN4157	" "
*For Asia, Latin America, Middle East and Africa areas.		
P2	QPA0602	Cushion-A
P3	QPA0603	Cushion-B
P4	XZB40X60A02	Poly Bag
P5	QPC0072	Sheet
P6	QPS0434	Pad
*For all European areas and Australia except United Kingdom.		

REPLACEMENT PARTS LIST

Important safety notice
 Components identified by Δ mark have special characteristics important for safety.
 When replacing any of these components, use only manufacturer's specified parts.

Ref. No.	Part No.	Part Name & Description
CABINET PARTS		
G1	QYT0612	Volume Knob
G2	QGC1202	Case Cover
	"Silver Type"	" "
	QGC1202K	" "
	"Black Type"	" "
G3	XTB4+8BFN	Tapping Screw $\oplus 4 \times 8$
	"Silver Type"	" "
	XTB4+8BFZ	" "
	"Black Type"	" "
G4	XTN3+10B	Tapping Screw $\oplus 3 \times 10$

Service Manual

Cassette Deck

RS-M205

(Silver Face)
(Black Face)

Metal Tape Compatible Stereo
Cassette Deck with Soft-Touch Controls
and Rewind Auto-Play Convenience

RS-M24 MECHANISM SERIES

*  DOLBY SYSTEM

Please use this manual together with the service manual for model No. RS-M205 (Original) order No. ARD81030032C8-10 and RS-M205 (For United Kingdom) order No. ARD81070069A2-01.

This is the Service Manual for the following areas.





-  For all European areas except United Kingdom.
-  For United Kingdom.
-  For Asia, Latin America, Middle East and Africa areas.
-  For Australia.

PARTS COMPARISON TABLE:

Please revise the original parts list in the Service Manual (RS-M205) to conform to the changes shown herein.

If new part numbers are shown, be sure to use them when ordering parts.

• Important safety notice
Components identified by  mark have special characteristics important for safety.
When replacing any of these components, use only manufacturer's specified parts.

Ref. No.	Part Name & Description	Part Numbers		Remarks
		Former Type	New Type	
M70	Takeup Gear Assembly	QXG1047	QZK0241 (M70)	
M75	Connection Pulley	QDP1823		
R117, 118   	Resistors		ERD25FJ681 (680Ω)	Added
*For all European areas except United Kingdom, Australia, Asia, Latin America, Middle East and Africa areas.				
C107, 108	Capacitors	ECQV05104JZ (0.1μF)	ECKD1H223ZF (22000pF)	
IC1, 2	Integrated Circuits	NE646B	NE646N	
E6  	AC Power Cord	SJA88	QFC1205M	
*For United Kingdom.				
G7  	Step Screw	QH1299	QH1313	
*For all European areas except United Kingdom, Australia, Asia, Latin America, Middle East and Africa areas.				
G10  	Holder Spring	QBP1771	QBP1923	
*For all European areas except United Kingdom, Australia, Asia, Latin America, Middle East and Africa areas.				
G15  	Eject Button Assembly	QXL1363	QXL1463	
*For all European areas except United Kingdom, Australia, Asia, Latin America, Middle East and Africa areas.				
G16  	Record Button Assembly	QXL1364	QXL1464	
*For all European areas except United Kingdom, Australia, Asia, Latin America, Middle East and Africa areas.				
G17  	Rewind Button Assembly	QXL1365	QXL1465	
*For all European areas except United Kingdom, Australia, Asia, Latin America, Middle East and Africa areas.				
G18  	Fast Forward Button Assembly	QXL1366	QXL1466	
*For all European areas except United Kingdom, Australia, Asia, Latin America, Middle East and Africa areas.				
G19  	Playback Button Assembly	QXL1367	QXL1467	
*For all European areas except United Kingdom, Australia, Asia, Latin America, Middle East and Africa areas.				
G20  	Stop Button Assembly	QXL1368	QXL1468	
*For all European areas except United Kingdom, Australia, Asia, Latin America, Middle East and Africa areas.				
G21  	Pause Button Assembly	QXL1369	QXL1469	
*For all European areas except United Kingdom, Australia, Asia, Latin America, Middle East and Africa areas.				
A1  	Instruction Book	QQT3031	QQT3161	
*For United Kingdom and Australia.				

* 'Dolby' and the double-D symbol are trademarks of Dolby Laboratories.

Technics

Matsushita Electric Trading Co., Ltd.
P.O. Box 288, Central Osaka Japan

SCHEMATIC DIAGRAM (ADDITION)

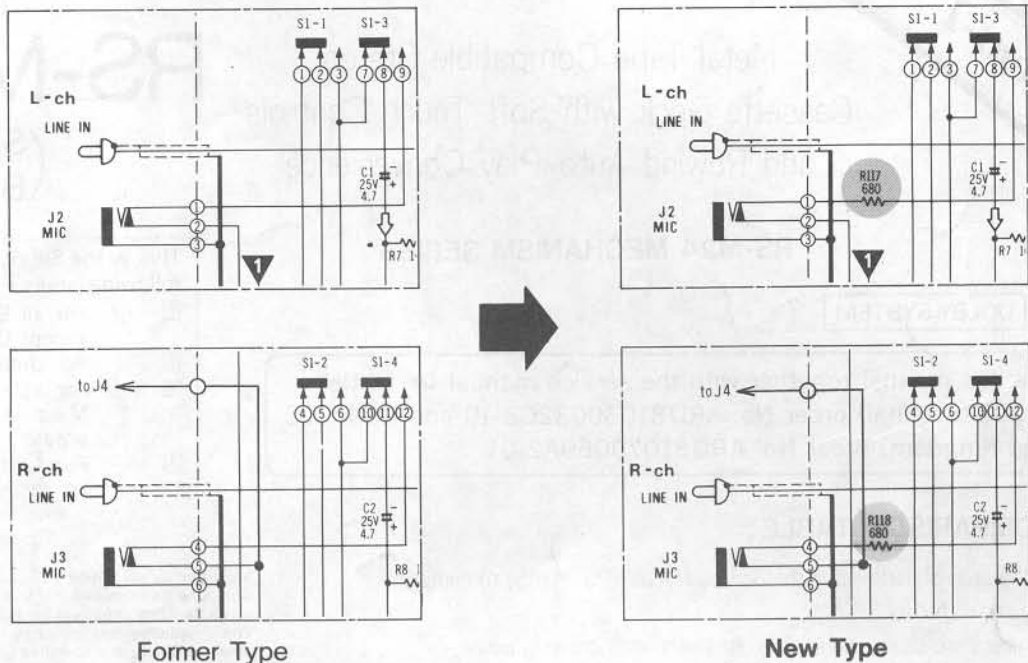

* For all European areas except United Kingdom, Australia, Asia, Latin America, Middle East and Africa areas.

CIRCUIT BOARD (ADDITION)

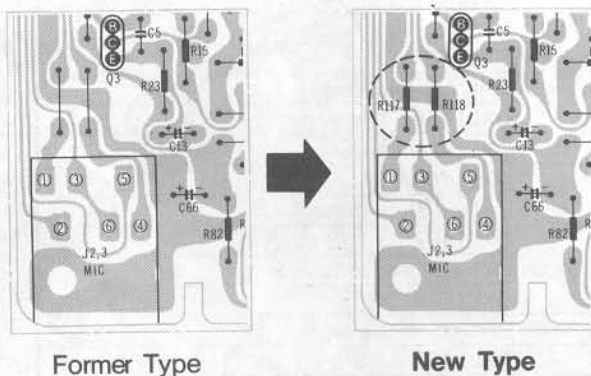

* For all European areas except United Kingdom, Australia, Asia, Latin America, Middle East and Africa areas.

MECHANICAL PARTS LOCATION (DIFFERENCE)

