

# technical manual for model S-36A radio receiver

## *Guarantee*

This receiver is guaranteed to be free from any defect in workmanship and material that may develop within a period of ninety (90) days from date of purchase, under the terms of the standard guarantee, as designated by the Radio Manufacturers Association. Any part or parts that prove defective within this period will be replaced without charge when subjected to examination at our factory, providing such defect, in our opinion, is due to faulty material or workmanship, and not caused by tempering, abuse or normal wear. All such adjustments to be made F.O.B. the factory. Should this receiver require any adjustments, your dealer or distributor has complete technical service information, or the factory will be glad to assist you

in any problem direct.

Should it be necessary to return any part or parts to the factory, a "Return Material Permit" must be obtained in advance by first writing the Adjustment Department, who will issue due authorization under the terms of the guarantee.

The Hallicrafters Co. reserves the right to make changes in design or add improvements to instruments manufactured by them, without incurring any obligation to install the same in any instrument previously purchased.

All Hallicrafters receivers are built under patents of Radio Corporation of America and Hazeltine Corporation.

JANUARY, 1946

TM 94-075

**the hallicrafters co**

MANUFACTURERS OF RADIO AND ELECTRONIC EQUIPMENT, CHICAGO 16, U.S.A.

# TABLE OF CONTENTS

---

Subject	Page
<b>I DESCRIPTION</b>	
1. General . . . . .	1-1
2. Description Of Main Components. . . . .	1-1
3. Frequency Coverage. . . . .	1-2
4. Power Requirements. . . . .	1-2
5. Main Components - Weights and Dimensions. . . . .	1-2
<b>II INSTALLATION AND ADJUSTMENT</b>	
1. Installation. . . . .	2-1
2. Preparation For Use . . . . .	2-2
3. Adjustment. . . . .	2-2
<b>III OPERATION</b>	
1. Controls and Their Functions. . . . .	3-1
2. Operation . . . . .	3-2
3. Station Logging . . . . .	3-4
<b>IV FUNCTIONING OF PARTS</b>	
1. General . . . . .	4-1
2. Detailed Functioning By Stages. . . . .	4-2
<b>V MAINTENANCE</b>	
1. Preventive Maintenance. . . . .	5-1
2. Replacing Tubes, Lamps, and Fuses . . . . .	5-2
3. Periodic Adjustments. . . . .	5-3
4. Locating Faults With A Volt-Ohm Meter . . . . .	5-7
<b>VI SUPPLEMENTARY DATA</b>	
1. Frequency Range . . . . .	6-1
2. Power Input . . . . .	6-1
3. Audio Power Output. . . . .	6-1
4. Sensitivity . . . . .	6-1
5. Audio Fidelity. . . . .	6-1
6. Image Ratio . . . . .	6-1
7. Selectivity . . . . .	6-1
8. Overall Weight. . . . .	6-1
9. Overall Dimensions. . . . .	6-1
<b>VII DRAWINGS</b>	
<b>VIII PARTS LIST</b>	

## LIST OF ILLUSTRATIONS

---

Figure	Title	Page
1-1.	Radio Receiver Model S-36A, front view. . . . .	1-0
2-1.	Radio Receiver Model S-36A, wiring diagram for d-c power plug . . .	2-2
4-1.	Radio Receiver Model S-36A, block diagram . . . . .	4-1
5-1.	Radio Receiver Model S-36A, view showing alignment points . . . . .	5-3
5-2.	Radio Receiver Model S-36A, voltage chart . . . . .	5-8
5-3.	Radio Receiver Model S-36A, resistance chart. . . . .	5-9
7-1.	Radio Receiver Model S-36A, top view. . . . .	7-0
7-2.	Radio Receiver Model S-36A, bottom view . . . . .	7-1
7-3.	Radio Receiver Model S-36A, rear view . . . . .	7-2
7-4.	Radio Receiver Model S-36A, outline dimensions. . . . .	7-3
7-5.	Radio Receiver Model S-36A, recommended antenna installations . . .	7-4
7-6.	Radio Receiver Model S-36A, tube socket connections . . . . .	7-5
7-7.	Radio Receiver Model S-36A, schematic wiring diagram. . . . .	7-7



Figure 1-1. Radio Receiver Model S-36A, front view.

# SECTION I DESCRIPTION

## 1. GENERAL.

The Model S-36A radio receiver (Fig. 1-1) is a very-high frequency superheterodyne receiver capable of accepting either amplitude-modulated (A-M) or frequency-modulated (F-M) phone signals and continuous wave (C-W) code signals in the 27.8 to 143 megacycle frequency range. Automatic volume control (A-V-C) and automatic noise limiter (A-N-L) circuits are incorporated to improve the performance of the equipment. The unit may be operated with its internal power supply from a 115-volt or 230-volt, 50/60 cycle single phase source or from an external supply which will provide direct current at 6.3-volts and 270-volts. The receiver is self contained except for headset, speaker, and antenna. It is normally supplied with a heavy sheet steel cabinet for table top installation as shown, although the receiver chassis may be removed from the cabinet and mounted directly onto a standard rack without any mechanical alterations.

## 2. DESCRIPTION OF MAIN COMPONENTS.

a. **Model S-36A Radio Receiver.** - The receiver is housed in a well ventilated cabinet with a hinged lid that provides access to all tubes and adjustments with the exception of the three acorn type tubes that are made accessible by removing the shield cover over the r-f section. The following controls, all plainly marked, are located on the front panel: R.F. GAIN, BAND SWITCH, ANTENNA, SELECTIVITY, TONE, TUNING, PITCH CONTROL, A.M./F.M., and A.F. GAIN. In addition to the controls, there are four toggle switches marked for the circuits in which they are used, namely, A.V.C., SEND/REC., A.N.L., and B.F.O. The meter in the upper right hand corner of the panel provides a visual indication of the relative signal strength for a-m reception and aids in centering the carrier for f-m reception. The frequency of reception is read directly from the main tuning dial located to the left of the TUNING control. The outer logging scale operates in conjunction with the vernier logging dial located just above the TUNING control. All external connections, with the exception of the headset, are made at the rear of the chassis. They are: A-C line cord, 500 and 5000-ohm speaker output, d-c power input, and antenna and ground connection.

### b. Tube Complement. -

Symbol	Tube Type	Function
V-1	956	R-F amplifier
V-2	954	Mixer
V-3	6AC7	1st i-f amplifier
V-4	6AB7	2nd i-f amplifier
V-5	6SK7	3rd i-f amplifier
V-6	6H6	A-M detector and noise limiter
V-7	6AC7	F-M limiter
V-8	6H6	F-M discriminator
V-9	6SL7GT	Audio voltage phase inverter
V-10	OD3/VR-150	Voltage regulator
V-11	6V6GT/G	Audio power amplifier
V-12	6V6GT/G	Audio power amplifier
V-13	5U4G	Rectifier
V-14	6J5	Beat-frequency oscillator
V-15	955	High-frequency oscillator

### 3. FREQUENCY COVERAGE.

The Model S-36A radio receiver provides continuous coverage over the frequency range 27.8 to 143 megacycles in three bands. Each band is provided with sufficient overlap to insure continuity of coverage over the entire tuning range.

### 4. POWER REQUIREMENTS.

The receiver is designed to operate from either a 115-volt or 230-volt 50/60 cycle, single phase, a-c source or from a 6-volt storage battery and 270-volt "B" battery. The "B" batteries may be replaced by a suitable vibrator type power supply if it meets the following current requirements.

A-C Operation	* D-C Operation
Line voltage . . .115 volts, 230 volts	Filament voltage . . . . . 6.3 volts
Line current . . .1.0 amp., 0.5 amp.	Filament current . . . . . 4.5 amps.
Power consumption. . . . . 115 watts	"B" voltage. . . . . 270 volts
	"B" current . . . . . 145 ma.

\* The 6-volt battery drain using a vibrator type supply for "B" voltage will run approximately 20 to 22 amperes.

### 5. MAIN COMPONENTS -- WEIGHTS AND DIMENSIONS.

Component	Dimensions (inches)			Weight (lbs.)
	Height	Width	Depth	
Model S-36A Radio Receiver	9-5/16	19-1/8	15-3/4	78
Receiver chassis only	8-3/4	19	15-3/4	61

## SECTION II

# INSTALLATION AND ADJUSTMENT

---

### 1. . INSTALLATION.

**a. Unpacking.** - Carefully unpack and inspect the equipment for any possible damage during shipment. In case of damages, a claim should be filed immediately with the transportation company.

**b. Mounting.** - The receiver as supplied is designed for table top operation, hence is equipped with rubber feet. The alternate rack mounting installation requires the removal of the chassis assembly from the cabinet before installing the unit in the rack. (See Fig. 7-3.) A chassis bottom plate and dust cover are recommended for this type of installation.

**c. Antenna Recommendations.** - Three terminals are provided on the antenna terminal board (TS-2) located on the rear apron of the receiver chassis. Terminals A<sub>1</sub> and A<sub>2</sub> are connected to the primaries of the first r-f stage transformers and the GND (ground) terminal is connected to the receiver's ground system. Refer to Fig. 7-5. for suggested antennas.

(1) **Single Wire Antenna.** - When using a single wire antenna installation, connect a jumper between the antenna terminals A<sub>2</sub> and GND. A single wire antenna of about 50 to 75 feet (including lead-in) is then connected to terminal A<sub>1</sub>. Use a No. 14 (AWG) or heavier wire for best results. Erect the antenna as high and free from surrounding objects as possible. This type of antenna works well where the signal to noise ratio is relatively high and a more elaborate installation is not available.

(2) **Doublet Antenna.** - The doublet antenna is recommended where receiving conditions are bad or where maximum sensitivity is required over a relatively narrow range of frequencies. The transmission line from the antenna is connected to terminals A<sub>1</sub> and A<sub>2</sub>. If a concentric line with a grounded outer conductor is used, connect the inner conductor to terminal A<sub>1</sub> and the outer conductor to terminal A<sub>2</sub>, and connect a jumper between terminals A<sub>2</sub> and GND. To determine the proper length in inches of the doublet antenna, divide 5540 by the frequency of reception in megacycles. After cutting the wire to the length determined above, cut it in half and insert an insulator at that point. Wrap and solder the two wires of the transmission line to each of the quarter-wave sections at the insulator. Refer to Fig. 7-5. Keep in mind that this type of antenna is directional broadside to its length and should be so orientated if maximum pick-up from a given direction is desired. The multiple dipole antenna shown in Fig. 7-5, is a modification of the conventional doublet antenna. Its purpose is to provide good reception over a wider range of frequencies than that obtainable with the single frequency doublet installation.

**d. Audio Output Connections.**-A headset or loudspeaker may be used with the receiver.

(1) The headset jack marked PHONES, located on the front panel, provides a 600-ohm balanced output for headset reception. The center tap of the 600-ohm headset winding is grounded externally at the speaker output terminal board TS-1 by a jumper wire across the terminals marked 600 C.T. If it is desirable to operate with one side of the headset line grounded, disconnect the jumper on terminal board TS-1.

(2) The two sets of speaker terminals located on the rear chassis apron provide output impedances of 500 and 5000 ohms for loudspeaker reception. One side of each of the 500 and 5000-ohm output connections is grounded. This should be kept in mind if this receiver is to work in conjunction with other equipment. A speaker capable of handling 5 watts of audio power should be used with this equipment.

e. **Remote Operation Facilities.** - The receiver may be disabled remotely by disconnecting the jumper wire between pins #3 and #4 in the shorting plug PL-2, which is normally plugged into socket SO-1 during a-c operation, and connecting a remote switch or relay across these pins. The stand-by switch is connected in the "B" lead, hence, the remote stand-by switch must be insulated for approximately 270 volts to protect the operator. When using the remote control disabling switch, the SEND/REC switch on the receiver must be set at SEND.

CAUTION - The external stand-by switch and its connections will be approximately 270 volts above ground hence must be well insulated throughout.

## 2. PREPARATION FOR USE.

a. **A-C Operation.** - The receiver may be operated from either a 115-volt or 230-volt, 50/60 cycle, single phase, a-c source of power. To change over from one line voltage to the other, it is merely necessary to throw the line voltage switch (SW-10) located on the top of the chassis near the power transformer. See Fig. 7-1. for location of the line voltage switch.

CAUTION - Check the line voltage and position of the line voltage switch before connecting the receiver to a source of power. A receiver set for 230-volt operation will not be damaged when connected to a 115-volt line, but a receiver set for 115-volt operation will, in most cases, be damaged when plugged into a 230-volt outlet. When in doubt, set the line voltage switch for 230-volt operation. If the dial lamps light up dimly, indicating a 115-volt line voltage, switch over to the 115-volt position.

b. **D-C Operation.** - The receiver may be operated from a 6-volt d-c source, generally a storage battery, and a 270-volt d-c supply in the form of dry batteries or vibrator type power pack. Consult the chart on power requirements for d-c operation in Section I. and provide battery facilities capable of supplying these demands. The receiver is connected to the d-c supply as follows:

(1) Remove the octal "jumper plug" (PL-2) used for a-c operation from socket SO-1. Use No. 18 (AWG) wire leads for the 270-volt "B" supply connections to pins #3 and #5 and No. 12 (AWG) wire leads for the 6-volt "A" battery connections to pins #1, #8 and #7.

CAUTION - Check your wiring carefully before connecting up to the battery supply.

c. **Pre-Operation Check.** - The following checkup on a newly installed piece of equipment is recommended before turning on the power for the first time.

(1) See that the tubes are securely seated in their sockets. Refer to Fig. 7-1. for the proper location of each tube.

NOTE - The three acorn type tubes are made accessible by removing the shield cover over the r-f section.

(2) Check the Pilot lamps behind the dial escutcheon. See that they are securely in place.

(3) Check the line fuse (FS-1) located on the front panel to see that it is in operating order. A visual check is generally sufficient.

(4) Check all external connections to the antenna terminals, speaker terminals, etc. See that they are secure and make positive contact. Remember that an improvised installation gives improvised results.

## 3. ADJUSTMENTS.

No preliminary adjustments are required on this equipment to put it into operation as the receiver has been properly aligned and tested at the factory before shipment.

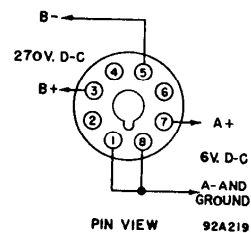

Fig. 2-1. Radio Receiver Model S-36A, wiring diagram for d-c power plug.



## SECTION III

### OPERATION

#### 1. CONTROLS AND THEIR FUNCTIONS.

Scanning across the front panel from left to right, the control markings and their functions are as follows: (Refer to Fig. 1-1.)

a. **R.F. GAIN Control.** - The radio frequency gain control regulates the sensitivity of the receiver. Turning the control to the right increases the sensitivity of the receiver. Ganged to this control is the "S" meter switch which connects the tuning meter into the circuit when the control is advanced all the way to the right.

b. **A.V.C. Switch.** - The automatic volume control switch when set at ON, provides a constant audio output level over reasonable variations in signal strength at the antenna. That is, it automatically controls the sensitivity of the receiver when this circuit is in operation. The A.V.C. switch must be set at ON to use the tuning meter.

c. **BAND SWITCH.** - The band switch selects one of the three bands or ranges available to the operator. The frequencies covered by each band switch position are read directly from the main tuning dial escutcheon. Each range has sufficient overlap to provide continuous coverage over the total 27.5 to 143 mc. range.

d. **ANTENNA Control.** - This control is used to compensate for misalignment of the receiver's antenna stage due to antenna impedance variations. Once set for a given antenna, its setting will hold for a wide range of frequencies.

e. **SEND/REC. Switch.** - Use this switch for stand-by purposes when the receiver is to be disabled for short periods of time. This switch disconnects the d-c plate voltage from the receiver and leaves the tube heaters at operating temperature for instant use.

f. **SELECTIVITY Switch.** - The selectivity switch serves a dual purpose. In position #1 it turns the receiver off when operating from an a-c source of power. (When operating from a d-c supply the power switch is part of the external supply, hence, the SELECTIVITY switch does not function in position #1). In positions #2 and #3 the selectivity switch controls the bandwidth of the i-f amplifier thereby affecting the selectivity of the receiver. In general, the switch is set at SHARP for amplitude modulated signals and at BROAD for frequency modulated signals.

g. **TONE Control.** - The tone control, as its name implies, adjusts the tone qualities of the aural signal for either headset or loudspeaker reception. The four types of response available are LOW, NORMAL, HIGH FID. (High fidelity) and BASS BOOST.

(1) **LOW.** - The bass and high frequencies are attenuated to provide a response for voice frequencies only.

(2) **NORMAL.** - The bass and high frequencies are attenuated somewhat less than for the LOW position providing a response for more than the ordinary voice frequencies. This position is preferred for voice communication when the signal to noise ratio will permit.

(3) **HIGH FID. (High fidelity).** - The bass and high frequencies are passed at the same level as the mid-frequency range thereby providing as near a true reproduction of the original audio signal as possible. The response is ordinarily uniform between 50 and 15,000 cycles per second for high fidelity reception.

(4) **BASS BOOST.** - The response in the high frequency end of the audio range remains uniform as for the HIGH FID. switch position, however the level of the low frequencies is boosted above the level of the mid-and high-frequency ranges.

**h. A.N.L. Switch.** - The automatic noise limiter switch cuts in a circuit which clips the noise voltage peaks generated by electrical disturbances, thereby providing intelligible reception in cases where reception would be normally impossible. This feature will not totally remove the noise but will do a good job of limiting it to reasonable levels.

**i. TUNING Control.** - This control tunes the receiver to the desired frequency of reception. The frequency of reception is read directly on the main tuning dial located to the left of the control. The logging dial located directly above the TUNING control is used in conjunction with the logging scale (outer scale) of the main tuning dial. Refer to the discussion on logging in this section.

**j. METER ADJ.** - This adjustment sets the tuning meter to its zero signal level position when the receiver is set for A.M. (amplitude modulation) reception. The adjustment is made with a screw driver and once set, it is seldom necessary to make any further adjustments. Refer to Par. 3. a. Section V. for adjustment details.

**k. PITCH CONTROL.** - The pitch control adjusts the pitch of the c-w signal when receiving c-w code signals.

**l. B.F.O. Switch.** - The beat-frequency-oscillator switch turns on a local oscillator used to produce the beat note necessary for c-w reception.

**m. A.M./F.M.** - This switch changes over the receiver for either amplitude-modulation (A.M.) or frequency-modulation reception (F.M.).

**n. A.F. GAIN Control.** - The audio frequency gain control or volume control as it is often called, sets the audio signal level at the speaker or headset. The control is set for a level most pleasing to the operator.

**o. "S" Meter or Tuning Meter.** - The tuning meter serves two functions in the receiver depending on the type of reception as follows:

(1) **A.M. Reception.** - When the receiver is adjusted to receive amplitude modulated signals, the tuning meter indicates the relative carrier strength of the received signal. To put the meter in operation, turn the R.F. GAIN control to the right until the switch connected to its shaft clicks, and set the A.V.C. switch at ON.

(2) **F.M. Reception.** - When the receiver is adjusted to receive frequency modulated signals, the tuning meter is used to indicate resonance with the station carrier. As the receiver is tuned through the f-m carrier the indicator will deflect to one side of zero, return to zero and deflect an equal distance to the opposite side of zero, and finally return to zero as the carrier is completely passed. The zero center position in the middle of the swing represents the correct setting of the receiver tuning dial and indicates resonance with the station carrier.

## 2. OPERATION.

Listed below are the receiver controls and their settings for the three types of reception provided by this receiver, namely, amplitude and frequency modulated telephone and c-w code reception.

**a. A.M. (Amplitude Modulation) Telephone Reception** - To receive amplitude modulated telephone signals set the front panel controls as follows:

SELECTIVITY switch	-	Set at A.C. OFF when the receiver is not in use. Set at SHARP for reception of amplitude modulated phone signals.
SEND/REC. switch	-	Set at REC. (Set at SEND to disable receiver for short stand-by periods.)
BAND SWITCH	-	Set at range number corresponding to band covering desired frequency.
A.M./F.M. switch	-	Set at A.M.

- A.V.C. - Set at ON.
- R.F. GAIN control - Turn to the right until tuning meter switch ganged to the control snaps on.
- B.F.O. switch - Set at OFF.
- PITCH CONTROL - Not used.
- TUNING wheel - Set calibrated dial to frequency of desired signal, adjust for maximum tuning meter deflection.
- ANTENNA trimmer - Adjust for maximum tuning meter deflection.
- A.F. GAIN control - Adjust for desired volume at headset or loudspeaker.
- TONE control - Set to please the listener. Generally set at HIGH FID. or BASS BOOST when signal to noise ratio is high or at NORMAL or LOW when signal to noise ratio is low.
- A.N.L. switch - Normally set at OFF except when background noise is excessive.

**b. F.M. (Frequency Modulation) Telephone Reception.** - To receive frequency modulated telephone signals set the front panel controls as follows:

- SELECTIVITY switch - Set at A.C. OFF when the receiver is not in use. Set at BROAD for reception of frequency modulated phone signals.
- SEND/REC. switch - Set at REC. (Set at SEND to disable receiver for short stand-by periods.)
- BAND SWITCH - Set at range number corresponding to band covering desired frequency.
- A.M./F.M. switch - Set at F.M.
- R.F. GAIN control - Turn all the way to the right. (The switch ganged to this control does not operate during f-m reception).
- A.V.C. switch - Set at OFF.
- B.F.O. switch - Set at OFF.
- PITCH CONTROL - Not used.
- A.N.L. switch - Set at OFF
- TUNING wheel - Set calibrated dial to frequency of desired signal, adjust for "0" position of tuning meter marked for F-M tuning.
- ANTENNA trimmer - Adjust for minimum background noise (Control will only be effective on very weak signals.)
- A.F. GAIN control - Adjust for desired volume at headset or loudspeaker.
- TONE control - Set at BASS BOOST or HIGH FID.

c. C-W Code Reception. - To receive continuous wave (c-w) code signals set the front panel controls as follows:

- SELECTIVITY switch - Set at A.C. OFF when the receiver is not in use. Set at SHARP for reception of c-w code signals.
- SEND/REC. switch - Set at REC. (Set at SEND to disable receiver for short stand-by periods.)
- BAND SWITCH - Set at range number corresponding to band covering desired frequency.
- A.M./F.M. switch - Set at A.M.
- A.V.C. switch - Set at OFF.
- B.F.O. switch - Set at ON.
- PITCH CONTROL - Adjust to produce a 500 to 1000 cycle code signal.
- TUNING wheel - Set calibrated dial to frequency of desired signal. Tune for maximum signal level at headset or loudspeaker.
- R.F. GAIN control - Turn up as high as the signal strength of the code signal will allow. Too much gain will result in distortion of the signal.
- ANTENNA trimmer - Adjust for maximum signal level at the headset or loudspeaker.
- TONE control - Set at LOW or NORMAL.
- A.N.L. switch - Set at OFF.
- A.F. GAIN control - Adjust for desired volume at headset or speaker.

### 3. STATION LOGGING.

The frequency range shown on the main tuning dial is calibrated directly in megacycles. The outside scale, on the calibrated dial is used for logging purposes. The logging scale runs from 0 to 23. Each of the 23 divisions are further divided into 100 parts by the vernier dial scale, located just above the TUNING control. The vernier dial turns through 100 divisions as the calibrated dial moves through one division along the logging scale, hence, the log reading will be the calibrated dial reading followed by a decimal point and the vernier dial reading.

Example - Assume that the calibrated dial indicator rests between divisions 1 and 2 on the LOGGING SCALE and the vernier dial reads 60. Our log reading will then be 1.60. To retune the receiver to this setting again simply set the receiver's TUNING control so that the logging scale index falls between divisions 1 and 2 and the vernier dial indicates 60.

## SECTION IV FUNCTIONING OF PARTS

### 1. GENERAL.

Figure 4-1. shows, in a very simple block form, the plan of the circuit of the Model S-36A receiver. Note that the circuit is that of the conventional superheterodyne receiver up to the second i-f amplifier stage. The output of the 2nd i-f amplifier is fed to two channels, namely, the F-M signal channel and the A-M signal channel. The F-M channel consists of the f-m limiter and discriminator and the A-M channel consists of an additional i-f amplifier stage and second detector stage. The demodulated signal from both channels then feeds the same audio amplifier, being selected by the A.M./F.M. switch.

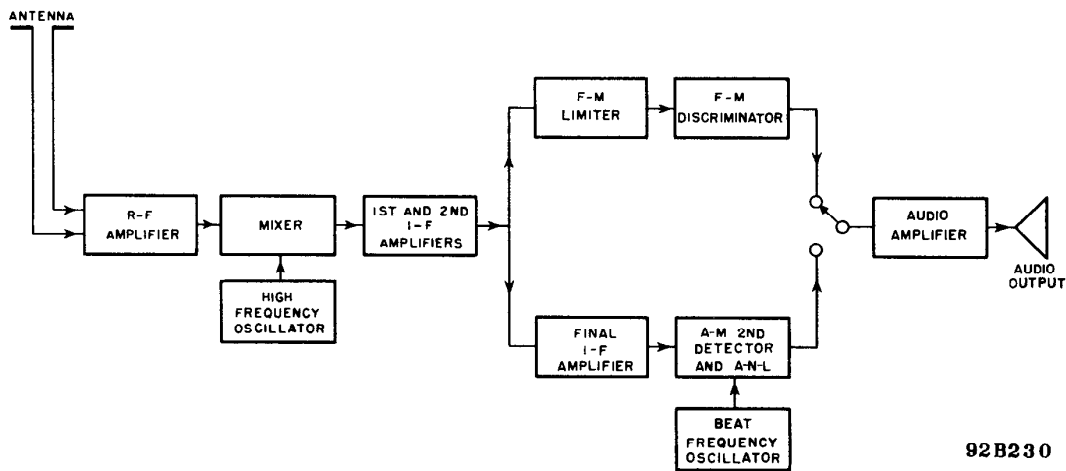

Fig. 4-1. Radio Receiver Model S-36A, block diagram.

### 2. DETAILED FUNCTIONING BY STAGES. (Refer to Fig. 7-7.)

Since the circuit functions of bands 1, 2 and 3 are essentially identical, this discussion will describe the circuit with BAND SWITCH (SW<sub>1A</sub> to SW<sub>1G</sub>) set at band 3 as shown in the schematic diagram.

a. R-F Amplifier. - The r-f amplifier stage employs a type 956 acorn type pentode tube in a conventional class A amplifier circuit. Signals present at the antenna are fed to the primary of transformer T-3 through terminals A<sub>1</sub> and A<sub>2</sub> of the antenna terminal strip TS-2. The secondary is tuned by the ganged tuning capacitor section C-1A and trimmer C-2. Trimmer capacitor C-2 is controlled from the front panel by the control marked ANTENNA to provide accurate alignment of the r-f stage with varying antenna load impedances. R-F signals selected by the parallel resonant circuit are applied to the grid of tube V-1 and appear in greater amplitude across the primary of transformer T-6. Parasitic resistor R-26 prevents unwanted oscillations in this stage and tends to stabilize the amplifier. Resistor R-1 by-passed by capacitor C-4 provides self-bias for the stage. Resistor R-2 and capacitor C-5 act as decoupling network for the screen of tube V-1 and resistor R-3 and R-4 and capacitors C-6 and C-78 act as decoupling networks for the plate circuit. The signal across the primary of transformer T-6 is coupled to the grid of tube V-2 inductively by transformer T-6 and capacitively by capacitor C-7. Capacitor C-7 provides a small amount of coupling to improve the response at the high frequency end of the band, thus equalizing the r-f signal amplitude over the tunable frequency range. The signal developed at the grid of tube V-2 then feeds the mixer stage of the receiver.

**b. Mixer.** - The mixer stage employs a type 954 acorn type pentode in a cathode coupled mixer circuit. The secondary of transformer T-6 is tuned by section C-1B of the ganged tuning capacitor and trimmer C-65. R-F signals selected by the parallel resonant circuit are applied to the grid of the mixer tube, V-2. A signal from the local oscillator 5.25 mc higher in frequency than the received signal on band #1 and 5.25 mc. lower in frequency than the received signal on bands #2 and #3 is fed to the mixer tube through the cathode and provides the difference frequency of 5.25 mc for the i-f amplifier stages.

**c. Oscillator.** - The oscillator circuit consists of a type 955 acorn type triode in a tuned-plate untuned grid type of oscillator circuit. The frequency of oscillation is determined by a resonant circuit consisting of the secondary of transformer T-9 and section C-1C of the main tuning capacitor connected in parallel. Capacitor C-11 is used to trim transformer T-9 (Band #3) only, although it remains in the circuit on bands #1 and #2. The r-f energy is fed from the plate of tube V-15 to the tuned circuit by the d-c blocking capacitor C-56. The decoupling network in the plate circuit of the oscillator tube consists of R-63, L-1, C-55 and R-62. Resistor R-66 (in band #3 only) and capacitor C-57 (in all bands) in series with the feed-back winding of transformer T-9 provide grid voltage across resistor R-64 for the oscillator tube. The oscillator voltage is supplied for the mixer stage by a third winding on transformer T-9 which is fed to the mixer tube (V-2) through capacitor C-9.

**d. First and 2nd I-F Amplifier.** - The 1st and 2nd i-f amplifier stages employ type 6AC7 and 6AB7 pentodes respectively. The i-f amplifier coupling transformers T-10, T-11, and T-12 for these two stages are tuned to 5.25 mc. by adjusting the powdered iron core slugs in both primary and secondary windings. The gain of the 1st and 2nd i-f amplifier stages is varied by the R.F. GAIN control (R-11), connected in series with the cathodes of both tubes, to provide sensitivity control for the receiver instead of the usual practice of varying the gain of the r-f amplifier stages. This method of control permits the r-f amplifier stages to operate at maximum gain, thereby providing a high signal to noise ratio at all sensitivity settings. The a-v-c grid voltage is applied to this section of the receiver through the decoupling networks C-12, R-10, C-16, and R-19. The a-v-c voltage is supplied by the 2nd detector tube (V-6) during a-m reception and a small amount of voltage is also supplied for a similar purpose, from the limiter tube (V-7) during f-m reception. Since the 1st and 2nd i-f amplifier stages are used for both a-m and f-m reception, the band width of the i-f amplifier channel is varied to provide a relatively sharp frequency response for a-m reception (SELECTIVITY switch set at SHARP) and a relatively broad frequency response for f-m reception. (SELECTIVITY switch set at BROAD). The selectivity of the i-f amplifier is controlled by switching in a third winding which varies the coupling between the primary and secondary windings. In SHARP position, the coupling winding is disconnected and only the coupling between primary and secondary windings determines the band width of the i-f amplifier. In BROAD position, the coupling winding is introduced to increase the coefficient of coupling between primary and secondary winding. The increase in coupling broadens the i-f amplifier frequency response to accept f-m signals. The signal voltage supplied by the 2nd i-f amplifier is fed to the limiter and discriminator for f-m reception and to the 3rd i-f amplifier stage and 2nd detector for a-m reception.

**e. Final I-F Amplifier.** - The last i-f amplifier stage, used for a-m reception, employs a type 6SK7 pentode connected in a conventional class A amplifier circuit. The stage is coupled by transformers T-12 and T-13 which are tuned by adjustable powdered iron core slugs. Resistor R-25 by-passed by capacitor C-21 provides self-bias for the stage. The gain of this stage is not varied as was the case for the 1st and 2nd i-f amplifier stages. The amplified signal voltage developed across the secondary of transformer T-13 is then fed to the 2nd detector for demodulation of a-m signals.

**f. A-M 2nd Detector and A-N-L.** - Both the second detector and automatic noise limiter stages employ a single type 6H6 duo-diode. One diode section of tube V-6 serves as detector for amplitude modulated signals by rectifying the modulated carrier. The r-f filter for this type of detection consists of resistor R-31 and capacitors C-24 and C-26 connected in a pi-section. Automatic volume control voltage and audio frequency voltage is obtained from the load and voltage divider resistors R-33, R-34, and R-36. Resistor R-35 and capacitor C-8 serve as a-v-c decoupling. The

remaining diode section of tube V-6 serves as automatic noise limiter as follows: Capacitor C-25 becomes charged by the rectified carrier voltage and the time constant of this capacitor and the filter network associated with it is such that the audio frequency voltage variations do not alter this charge. During a severe noise pulse, however, the cathode of the diode plate connected to capacitor C-25 becomes more negatively charged than the charge held by capacitor C-25, hence, current flows shorting the audio voltage to ground through capacitor C-25 until the cathode voltage of the a-n-1 diode again reaches a less negative potential than its plate and capacitor C-25 acquires its normal charge again. By shorting the audio voltage to ground during a noise pulse, the a-n-1 circuit prevents the objectional noise pulses from reaching the audio amplifier stages.

**g. Beat Frequency Oscillator.** - The beat frequency oscillator employs a type 6J5 triode tube in a modified Hartley oscillator circuit. The oscillator frequency is adjusted by a moveable powdered iron core within the field of coil L-5. This iron core adjustment sets the oscillator's frequency at 5.25 mc. and is adjusted by a screw driver during alignment. The fine adjustment of the oscillator frequency required to provide control of the beat note frequency is controlled by variable capacitor C-60 (PITCH CONTROL) which tunes a small portion of the total oscillator coil (L-5). The B.F.O. switch controls the use of the oscillator by breaking the plate voltage lead to the tube. The decoupling network R-60 and C-52 prevents the oscillator signal from reaching the other stages through the "B" voltage supply.

**h. F-M Limiter and Discriminator.** - The frequency modulation detector consists of a limiter stage and a discriminator stage. The 6AC7 limiter tube (V-7) is fed by the second i-f transformer secondary winding along with the third i-f amplifier tube V-5 for a-m reception. The limiter stage operates as a saturated amplifier in which the output voltage remains constant over a large range of input voltage levels, thus eliminating variations in the amplitude of the carrier signal to be demodulated by the discriminator. When operating as an f-m receiver, automatic volume control action is obtained by applying a part of the voltage developed across resistor R-39 in the grid return of the limiter tube (V-7), to the control grids of the 1st and 2nd i-f amplifier tubes (V-3 and V-4) through section SW-8A of the A.M./F.M. switch. The constant level signal voltage from the limiter tube (V-7) is fed to the type 6H6 discriminator tube (V-8) through the discriminator transformer (T-14) and coupling capacitor C-29. The discriminator circuit, consisting of transformer T-14, tube V-9 and load resistors R-40 and R-41, converts the frequency variations of the f-m signal into amplitude variations of the audio signal. The de-emphasis network, consisting of resistor R-42 and capacitor C-32, attenuates the high frequency end of the audio range since these frequencies are emphasized as the f-m transmitter. From the de-emphasis network the audio signal is fed to the A.F. GAIN control (R-43) in the same way as the audio signal from the amplitude modulation detector tube (V-6).

**i. Audio Amplifier.** - The audio amplifier stages consists of a class A phase inverter amplifier employing a type 6SL7GT twin-triode driving a pair of 6V6GT/G pentodes in push-pull class A. The audio signal from either the a-m detector or the f-m discriminator is fed to the grid of the first triode section of the phase inverter tube (V-9) through the A.F. GAIN control (R-43). The amplified audio signal voltage from the first triode section of tube V-9 is fed to the grid of power amplifier tube V-12 and to the grid of the second triode section of tube V-9 through the voltage divider network consisting of resistors R-50 and R-51 which also serve as grid return for the power amplifier tube (V-12). The audio signal voltage developed across the plate load resistor (R-45) of the second triode section of tube V-9, which is now 180 degrees out of phase, is then fed to the remaining power amplifier tube (V-11) grid. The output of the power amplifier tubes is coupled to the load through transformer T-15, the secondary of which provides output impedances of 500 ohms and 5000 ohms to ground and 600 ohms balanced to ground. The network consisting of R-69, R-53 and C-35 supplies inverse feedback in various amounts to provide tone control ranging from bass boost to high frequency cutoff. The TONE switch SW-9 selects the required network combination.

**j. Tuning Meter.** - The tuning meter serves two circuits in the receiver depending upon the type of signals being received. It is switched from one circuit to the other by the A.M./F.M. switch (SW-8 sections B and C).

(1) **A-M Reception.** - When metering the reception of a-m signals, the tuning meter measures the plate current of the 2nd i-f amplifier tube (V-4) which varies with the strength of the signal carrier. Resistor R-58 sets the zero (no signal) position of the tuning meter by controlling that part of the plate current of tube V-4 flowing through the meter. The intermediate frequency signal voltage then drives the plate current of tube V-4 to a lower value depending upon the signal strength. The screen grid voltage of tube V-4 is regulated by the voltage regulator tube (V-10) to provide an accurate control over the zero signal plate current so that the meter adjustment resistor (R-58) need not be continually re-set for variations of the a-c line voltage.

(2) **F-M Reception.** - When metering reception of f-m signals the tuning meter measures the unbalanced current in resistors R-40 and R-41 obtained when the receiver is tuned to one side of the f-m carrier. When the receiver is tuned to the exact center of the f-m carrier the meter rests at zero indicating that the currents in the discriminator load resistors are equal. Resistor R-56 functions to limit the maximum current in the meter circuit to a safe value.

**k. Power Supply.** - The receiver has provisions for operation from either an a-c or d-c source.

(1) **A-C Operation.** - The receiver's power supply provides for operation from 115 or 230-volt a-c mains. The a-c current is fed through the line filter which is a low pass pi-section network connected in each side of the line. The network consists of inductances L-2 and L-3 and capacitors C-48, C-49, C-50 and C-51. The line filter attenuates all the objectionable noise components coming into the receiver circuit through the a-c power source. The line voltage at which the receiver will operate is determined by the setting of the line voltage switch SW-10. This switch simply connects the two 115-volt primary windings of transformer T-16 in parallel for 115-volt operation or series for 230-volt operation. A type 5U4G (tube V-13) full wave rectifier is employed in a conventional full wave rectifier circuit. The high voltage from this rectifier is fed to the filter network through the "Shorting Plug" on the rear apron of the receiver chassis as is the filament current for the heaters of the tubes. The SEND/REC. switch is connected in series with the high voltage lead from the rectifier filament to the shorting plug socket to break the high voltage circuit to the receiver's filter sections, thereby, disabling the receiver but at the same time keeping the tube heaters hot, ready for instant use. The filter circuit consists of two low pass pi-section networks made up of inductances L-6 and L-7 and capacitors C-42, C-43, and C-44. In order to provide a constant "B" voltage for the oscillator, mixer, and screen grid of the 2nd i-f amplifier stages a voltage regulator tube type 0D3/VR-150 is used. The voltage supplied to the screen of tube V-4 is regulated to provide accurate current control for the tuning meter connected in the plate circuit of this tube.

(2) **D-C Operation.** - External 6-volt storage battery and 270-volts of "B" batteries or storage battery and vibrator type supply provide for d-c operation. When operating from an external d-c supply the "Shorting Plug" on the rear apron of the receiver chassis is removed and a similar plug is wired to supply filament and plate current to the receiver circuits. The "B" voltage is fed to the input side of the filter sections used for a-c operation thereby insuring adequate filtering for vibrator type power supplies.



## SECTION V

# MAINTENANCE

---

CAUTION - Voltages at various points in this equipment are of sufficiently high potential to produce a severe shock. Locate the high-potential points on the VOLTAGE CHART before attempting to service circuits that are "hot". IT IS A GOOD RULE TO DISCONNECT THE POWER SOURCE BEFORE MAKING ADJUSTMENTS WHEN POSSIBLE. BE CAREFUL.

### 1. PREVENTIVE MAINTENANCE.

All components of the receiver should be given a thorough inspection at regular intervals. The time interval between inspections will be determined by the operating conditions of the individual installation. In general, keep the components clean and dry. Moisture, even in a completely tropicalized set may cause serious deterioration and produce general unsatisfactory operation. Dust and dirt materially effect both electrical and mechanical operation. Keep the various parts clean especially the tuning capacitors and associated gear drive. Dust should be blown out with dry air or brushed out carefully. Do not oil the gear teeth or the condenser wipers, as noisy reception will result from intermittent electrical contact at these points. Noisy reception may also be caused by dirty condenser wipers, faulty gain controls and switches, frayed cable connections, faulty tubes, etc. in the installation. Check accessible connections, switch contacts, etc. regularly, making sure that all are clean and tight and the tubes and cable connectors are held securely in their sockets.

### 2. REPLACING TUBES, LAMPS, and FUSES.

a. **Replacing Tubes.** - All tubes with exception of the three acorn types are accessible at the top of the chassis through the hinged cover of the cabinet. The three acorn type tubes are made accessible by removing the top cover of the r-f section which is held down by anchor clips. The acorn type tubes are inserted with the short end of the body in the socket. Acorn tubes are more fragile than the rest and must be handled accordingly. If the grid and plate clips on the connections to these tubes become loose replace or bend them to fit firmly. DO NOT ATTEMPT TO SOLDER DIRECTLY TO THE TUBE PIN as the heat generated by the soldering iron will crack the glass envelope. When replacing tubes, check the tube type carefully and replace with the correct tube type. Refer to the top view of the chassis to determine the location of the tubes and to the PARTS LIST for the type number and description of each.

b. **Replacing Lamps.** The receiver employs two lamps with bayonet type sockets to illuminate the calibrated tuning dial and the vernier dial. The lamps are to be replaced with a 6/S-volt, 250 ma. (blue bead) G.E. #44 or equivalent. The color code referred to is the color of the glass bead above the glass stem inside the envelope of the lamp.

### 3. PERIODIC ADJUSTMENTS.

#### a. Tuning Meter Adjustment. -

(1) The tuning meter zero setting control is located behind its front panel button type cover, marked METER ADJ. Remove the button with a knife or screw driver blade.

(2) Disconnect the antenna and connect a jumper across terminals A<sub>1</sub>, A<sub>2</sub>, and GND. on terminal board TS-2.

(3) Set the front panel controls for amplitude modulation reception as follows:

(a) Set A.M./F.M. switch at A.M.

- (b) Set A.V.C. switch at ON.
- (c) Turn R.F. GAIN control to right until the switch on the control clicks.
- (d) Set A.F. GAIN control for minimum gain. (All the way to the left.)
- (e) Set A.N.L. switch at OFF.
- (f) Set B.F.O. switch at OFF.
- (g) Set SEND/REC. switch at REC.
- (h) Set SELECTIVITY switch at SHARP.

(4) With a screw driver set the METER ADJ. control for the zero reading on the S-meter scale of the tuning meter.

(5) Remove the antenna terminal jumper and replace antenna leads and meter adjustment cover button, the adjustment is completed.

**b. Receiver Alignment.** - The receiver has been carefully aligned at the factory and should not require realignment until the receiver requires new tubes in the r-f and i-f amplifier stages, or shows signs of loss of sensitivity, off frequency calibration or requires service work on one or more of its r-f and i-f amplifier stages. Alignment should not be attempted by inexperienced personnel as maximum performance is obtained only by careful and intelligent alignment.

**(1) Aligning Tools. -**

(a) Signal generator capable of providing a 400-cycle modulated signal at 5.25 mc. and 27 to 145 mc. range. Recommended generators are the Ferris Instrument Corp. Model 18D or 18FS and the Measurements Corp. Model 75.

(b) A 50-ohm non-inductive dummy antenna resistor.

(c) Non-metallic screw driver. A bakelite screw driver with a short metal blade is very good.

(d) Audio output meter capable of handling 10 watts of audio power for either 500 or 5000-ohm loads.

**(2) I-F Amplifier Alignment. -**

(a) Disconnect the grid lead of the type 954 mixer tube (V-2) and connect the "hot" lead of the signal generator to the grid of the mixer tube using a small clip or flexible piece of wire to make the connection. Connect the ground wire of the generator to the receiver chassis.

CAUTION - Do not attempt to solder to the tube terminal as the heat of the soldering iron is certain to crack the glass envelope.

(b) Connect the output meter across the speaker terminals. Set the range of the output meter for its highest range to prevent overloading the meter accidentally.

(c) Let the receiver warm up for approximately half an hour, then set the receiver controls as follows:

R.F. GAIN control at maximum gain.

A.F. GAIN control at maximum gain. Work in a shielded room if possible.

SELECTIVITY switch at SHARP.

A.M./F.M. switch at A.M.

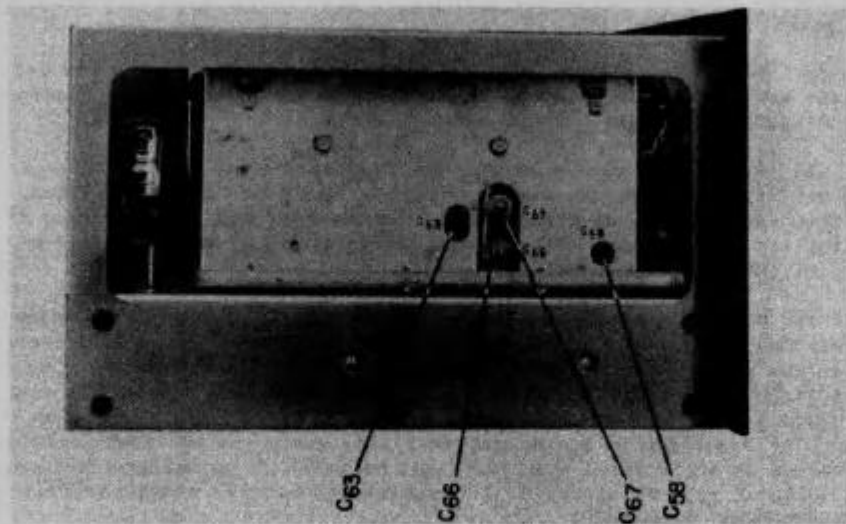
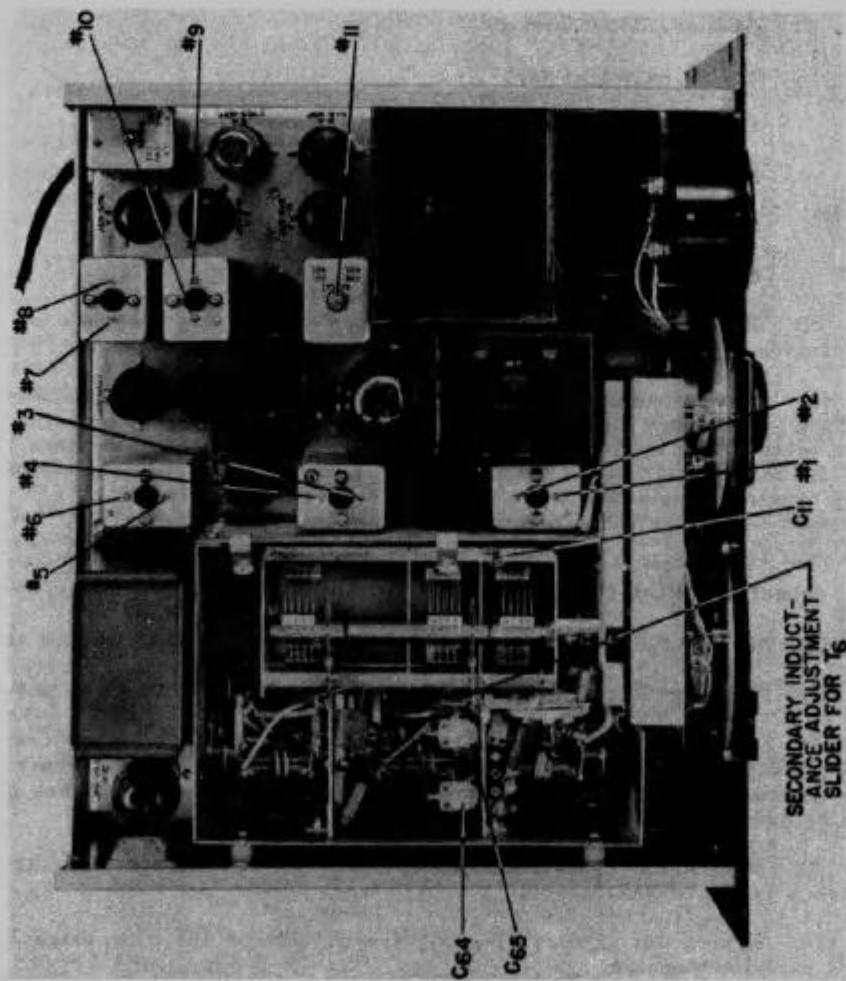

Figure 5-1. Radio Receiver Model S-36A, view showing alignment points.

BAND SWITCH at band #2.

A.V.C. switch at OFF.

SEND/REC. switch at REC.

A.N.L. switch at OFF.

B.F.O. switch at OFF.

TONE control at HIGH FID.

(d) Set the signal generator frequency at 5.25 mc. and turn on the 400-cycle modulation.

(d) Adjust transformers T-10, T-11, T-12 and T-13 for maximum output meter reading using just enough signal generator output to provide a good resonant swing on the output meter. The signal level at the generator should not be more than 70 microvolts for a 500 milliwatt audio output level. Repeat the alignment procedure until assured of accurate alignment. Refer to figure 5-1. for the location of i-f transformer adjustment screws #1 through #8 inclusive on i-f transformers T-10, T-11, T-12, and T-13.

### (3) Discriminator Transformer Alignment. -

(a) Set the A.M./F.M. switch at F.M. and the SELECTIVITY switch at BROAD.

(b) Leave the signal generator set at 5.25 mc. with 400-cycle modulation.

(c) Adjust the secondary slug (#10) of the discriminator transformer (T-14) for zero signal level at the output meter. Note that this adjustment is critical, therefore turn the adjustment screw slowly. Use sufficient signal generator output to provide a good null indication.

(d) Detune the adjustment made in par. (c) slightly so that the output meter gives a readable indication.

(e) Adjust the primary slug adjustment (#9) of the discriminator transformer for maximum response.

(f) Retune the secondary (slug #10) of the discriminator transformer for the null point as in par. (c).

(g) Detune the signal generator to a frequency lower than the i-f frequency until the maximum output point is reached. Note the output meter reading and the frequency deviation from the i-f frequency (5.25 mc.).

(h) Repeat the procedure for the frequency above the i-f frequency. The frequency deviation and maximum output should be the same for good balance. If they are not, then tune the signal generator to the lower of the two peaks and adjust the primary slug adjustment (#9) until the output rises an amount equal to about half the difference of the two peaks previously noted.

(i) Retest for balance as above readjusting the primary slug adjustment until both maximum readings are alike when the signal generator is detuned approximately the same amount on either side of resonance (5.25 mc.). If a balance cannot be obtained, it is an indication that the discriminator transformer secondary slug adjustment (#10) has been misadjusted and will require a very slight correction in either direction. The direction of adjustment that will cause the off-tune peaks to assume the same values is the correct one. Care must be taken in adjusting the discriminator secondary control as even a very slight misadjustment will result in distortion of frequency modulated signals.

(4) B.F.O. Adjustment. - Set up the receiver and signal generator as for i-f amplifier alignment and proceed as follows:

- (a) Shut off the 400-cycle modulation of the signal generator.
- (b) Set the PITCH CONTROL at "0" and set the B.F.O. switch at ON.
- (c) Back off the A.F. GAIN control slightly and use just enough signal generator output to provide a clean beat note.
- (d) Plug a headset into the PHONES jack.
- (e) Adjust the slug screw (#11) of coil L-5 for zero beat.
- (f) Check the adjustment by turning the PITCH CONTROL to the right and left of "0". A change in the pitch of the beat note should result. The frequency of the beat note will vary from zero at the "0" setting to a very high pitch at the #5 setting of the control.
- (g) Disconnect the signal generator and reconnect the grid lead to the mixer tube, the alignment of the i-f amplifier stages is complete.

(5) **R-F Amplifier Alignment.**— The following sequence must be followed to properly align the r-f amplifier stages. Band 3 is aligned first since the adjustment of trimmer C-11 is made for band 3 alignment only and will slightly effect the alignment of bands 1 and 2 if band 3 is not aligned first.

(a) Connect the "hot" lead of the signal generator to terminal "A<sub>1</sub>" of the antenna terminal board through a 50-ohm non-inductive resistor (carbon). Connect the ground lead of the generator to the receiver chassis. Leave the jumper connected between terminals "A<sub>2</sub>" and "GND". Turn on the 400-cycle modulation.

(b) Let the receiver warm up for approximately half an hour, then set the receiver controls as follows:

R.F. GAIN control at maximum gain.

A.F. GAIN control at maximum gain.

SELECTIVITY switch at SHARP during alignment of band 1. and at BROAD during alignment of bands 2 and 3.

A.M./F.M. switch at A.M.

A.V.C. switch at OFF.

SEND/REC. switch at REC.

A.N.L. switch at OFF.

B.F.O. switch at OFF.

TONE control at HIGH FID.

NOTE For all alignment adjustments the signal generator output attenuator must be adjusted to provide a 500 milliwatt audio signal output at the speaker terminals of the receiver.

NOTE - During each of the following adjustments the ANTENNA control should be touched up to keep the antenna stage in alignment.

(c) **Band 3. Alignment.** - (BAND SWITCH at 3.)

1. Set the signal generator at 135 mc. and tune in its signal on the receiver. If the receiver's calibrated dial reads 135 mc. no adjustment of capacitor C-11 is necessary if not, adjust C-11 for maximum output with the receiver dial set at 135 mc.

2. Set the signal generator at 90 mc. and tune in its signal on the receiver. If the receiver dial reads 90 mc. no adjustment of the plate winding inductance of transformer T-9 is necessary - if not, loosen the setscrew at the frame of the main tuning condenser (C-1), holding the end of the plate coil, and adjust the inductance. Increase the inductance if the generator signal falls lower than the 90 mc. calibration point on the receiver dial and reduce the inductance if the signal falls above the 90 mc. calibration point. Tighten down the set screw each time before checking the adjustment.

NOTE - If the plate coil inductance was altered it will be necessary to repeat step 1. again. Several adjustments of capacitor C-11 in step 1. and the plate coil inductance in step 2. may be required in cases of where a new transformer (T-9) had to be installed.

3. Set the signal generator and receiver at 135 mc. and adjust trimmer capacitor C-65 for maximum output. Rock the tuning control back and forth slightly to determine the best adjustment.

4. Ordinarily no adjustment of the secondary winding inductance of transformers T-3 and T-6 is necessary at 90 mc., however, if the sensitivity of the receiver falls off at this end of the range or if new transformers have just been installed it will be necessary to adjust the secondary winding inductance for maximum response at 90 mc. Transformer T-6 is provided with a soldered slider adjustment at the gang condenser frame, however, the ground side of the secondary of transformer T-3 must be unsoldered to be adjusted. The value of inductance that provides maximum audio signal at the output meter is the correct adjustment.

NOTE - If the secondary inductance was altered it will be necessary to repeat step 3. again. Several adjustments of capacitor C-65 in step 3. and inductance in step 4. may be necessary depending upon the condition of the coils.

(d) Band 2. Alignment. - (BAND SWITCH at 2.)

1. Set the signal generator at 80 mc. and tune in its signal on the receiver. If the receiver's calibrated dial reads 80 mc. no adjustment of capacitor C-67 is necessary - if not, adjust capacitor C-67 for maximum output with the receiver dial set at 80 mc.

2. Set the signal generator at 50 mc. and tune in its signal on the receiver. If the receiver dial reads 50 mc. no adjustment of the plate winding inductance of transformer T-8 is necessary - if not, it will be necessary to loosen the winding from the form with lacquer thinner and shift the individual turns until the signal peaks with the receiver dial set at 50 mc. Repeat step 1. above and recheck step 2. again before cementing the coil in place with Amphenol 912 cement.

NOTE - The presence of lacquer thinner may effect the winding inductance, hence, it is well to allow a few minutes for the lacquer thinner to evaporate before making inductance adjustments.

3. Set the signal generator and receiver at 80 mc. and adjust trimmer capacitor C-64 for maximum output. Rock the tuning control back and forth slightly to determine the best adjustment.

4. Ordinarily no adjustment of the secondary winding inductance of transformers T-2 and T-5 is necessary at 50 mc., however, if the sensitivity of the receiver falls off at this end of the range or if new transformers have just been installed it will be necessary to adjust the secondary winding inductance for maximum response at 50 mc. To adjust the secondary inductance it will be necessary to use lacquer thinner as in step 2. to loosen and shift turns until the signal peaks with the receiver dial set at 50 mc. Repeat step 3. above and recheck step 4. again before cementing the coils in place with Amphenol 912 cement.

(e) Band 1. Alignment. - (BAND SWITCH at 1.)

1. Set the signal generator at 45 mc. and tune in its signal on the receiver. If the receiver's calibrated dial reads 45 mc. no adjustment of capacitor C-66 is necessary - if not, adjust capacitor C-66 for maximum response with the receiver dial set at 45 mc.

2. Set the signal generator at 30 mc. and tune in its signal on the receiver. If the receiver dial reads 30 mc. no adjustment of the padder capacitor C-58 is necessary - if not, adjust capacitor C-58 for maximum output with the receiver dial set at 30 mc.

3. Set the signal generator and receiver at 45 mc. and adjust trimmer capacitor C-63 for maximum response. Rock the tuning control back and forth slightly to obtain the best adjustment.

4. Ordinarily no adjustment of the secondary winding inductance of transformers T-1 and T-4 is necessary at 30 mc., however, if the sensitivity of the receiver falls off at this end of the range or if new transformers have just been installed it will be necessary to adjust the secondary winding inductance for maximum response at 30 mc. To adjust the secondary inductance it will be necessary to use lacquer thinner as before to loosen and shift turns until the signal peaks with the receiver dial set at 30 mc. Repeat step 3. above and recheck step 4. again before cementing the coils in place with Amphenol 912 cement.

NOTE - After completing the above alignment procedure check the image frequency to determine whether the oscillator frequency is higher than the signal frequency on band 1. and lower than the signal frequency on bands 2 and 3. For example: Set the receiver dial at 100 mc., set the signal generator frequency at twice the i-f frequency lower than 100 mc. or 89.5 mc. and turn up the signal generator output to about 5000 times the normal alignment output. An image signal should be heard. If not, tune the signal generator to twice the i-f frequency higher than the signal frequency or 110.5 mc. and look for the image there. If the image shows up at 110.5 mc., the receiver's oscillator is operating above the signal frequency on this band and must be readjusted so that it falls below the signal frequency. Due to the construction of this receiver it is considered impossible to adjust the oscillator frequency so that it will fall on the wrong side of the signal frequency on any of the three bands, however, it is always well to check for the image after making any extensive alignment adjustments.

(f) When completely aligned the overall receiver sensitivity will usually run from 2 microvolts at 30 mc. to 10 microvolts at 130 mc. for 50 milliwatts audio output. If your receiver falls reasonably close to this sensitivity, consider your job finished.

#### 4. LOCATING FAULTS WITH A VOLT-OHM METER.

a. Voltage Chart. - Refer to Fig. 5-2. for the tube socket terminal voltages. Voltages shown are those between the terminal and ground (chassis) unless otherwise specified. To identify the tube socket connections, refer to Fig. 7-6. The readings were taken with an RCA Volt-Ohmyst Junior analyzer using 20,000 ohm per volt sensitivity. To prepare the receiver for measurement, disconnect the antenna, connect a jumper between the antenna terminals A<sub>1</sub>, A<sub>2</sub> and GND, disconnect the speaker and replace with a 5000-ohm 10-watt resistor across the 5000-ohm output terminals or a 500-ohm 10-watt resistor across the 500-ohm terminals, and set the controls as follows:

SELECTIVITY switch at SHARP

SEND/REC. switch at REC.

A.M./F.M. switch at A.M.

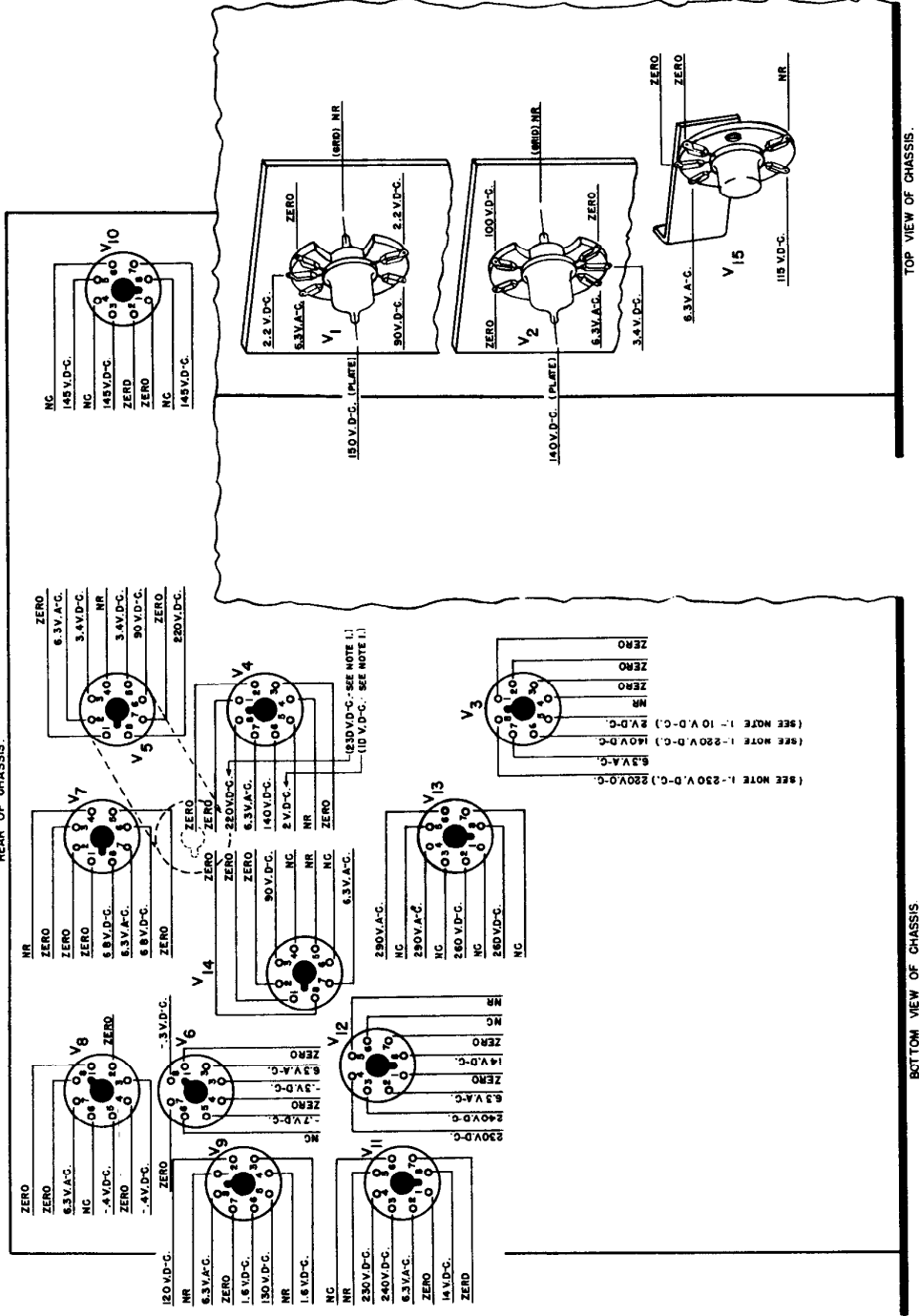
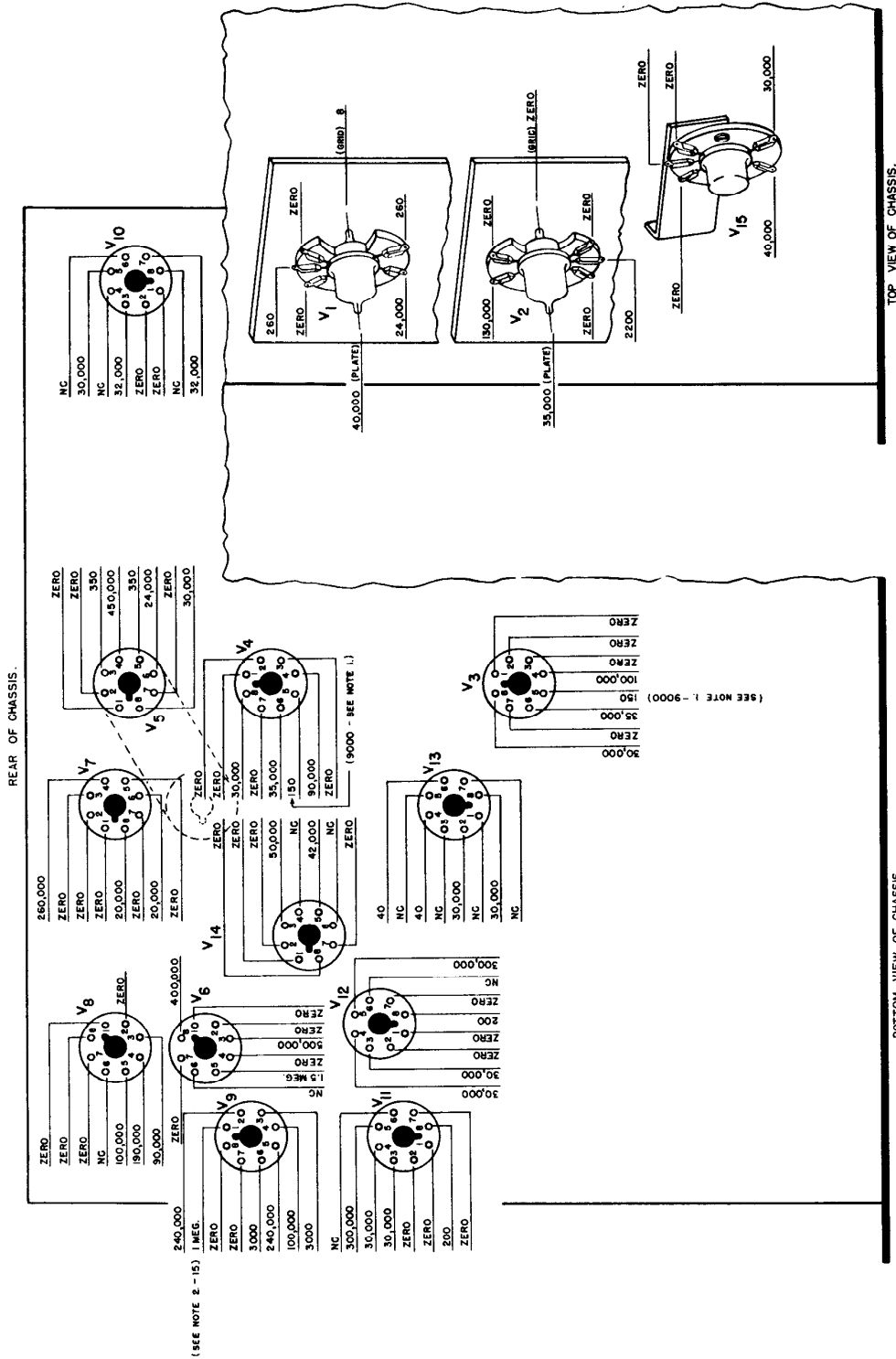

Figure 5-2. Radio Receiver Model S-36A, voltage chart.

NOTE 1. VOLTAGE READING WITH R.F. GAIN CONTROL SET AT MINIMUM GAIN POSITION.  
 2. NC = NO CONNECTION.  
 3. NR = NOT READABLE ON A 10,000 OHM PER VOLT METER.

920291





NOTE: 1. R.F. GAIN CONTROL SET AT MINIMUM GAIN POSITION.  
 2. A.F. GAIN CONTROL SET AT MINIMUM GAIN POSITION.  
 3. NC = NO CONNECTION.

Figure 5-3. Radio Receiver Model S-36A, resistance chart.

A.V.C., A.N.L., and B.F.O. switches at ON.

R.F. GAIN and A.F. GAIN controls at maximum gain position.

ANTENNA, TONE, TUNING, and PITCH CONTROL adjustments do not effect the readings.

**b. Resistance Chart.** - Refer to Fig. 5-3. for the tube socket terminal to ground (chassis) resistance measurements. To identify tube socket connections, refer to Fig. 7-6. The readings were taken with an RCA Volt Ohmyst Junior analyzer. To prepare the receiver for measurement, disconnect the a-c line cord and set the controls as follows:

SELECTIVITY switch at SHARP.

SEND/REC. switch at REC.

A.M./F.M. switch at A.M.

A.V.C., A.N.L., and B.F.O. switches at ON.

R.F. GAIN and A.F. GAIN controls at maximum gain position.

TONE control set at BASS BOOST.

ANTENNA, TUNING and PITCH CONTROL adjustments do not effect the readings.

**c. Checking Transformer and Inductor Windings With an Ohm-meter. -**

NOTE - One terminal of each winding measured must be disconnected from the circuit to avoid measuring circuit resistance instead of winding resistance alone as indicated in the chart.

Circuit Symbol	Name of Part	Winding	Winding Terminals	D-C Resistance (ohms)
T-15	TRANSFORMER, audio.	Primary	1 to 3	560
		$\frac{1}{2}$ primary	1 to 2/2 to 3	280
		600-ohm secondary	4 to 6	25
		$\frac{1}{2}$ 600-ohm secondary	4 to 5/5 to 6	12.5
		5000-ohm secondary	7 to 9	33
		500-ohm secondary	7 to 8	3
T-16	TRANSFORMER, power.	Primary #1	1 to 3	3.5
		Primary #2	2 to 4	3.5
		H.V. secondary	9 to 11	90
		$\frac{1}{2}$ H.V. secondary	8 to 10/10 to 11	45
		5.0-volt secondary	7 to 8	Zero
		6.3-volt secondary	5 to 6	Zero
L-6/L-7	Reactor, filter.	12-henry coil	1 to 2	215
		3-henry coil	2 to 3	85

## SECTION VI

### SUPPLEMENTARY DATA

---

#### 1. FREQUENCY RANGE.

27.8 mc. - 143 mc. (Covered in three bands).

#### 2. POWER INPUT.

##### a. A-C Operation. -

Line Voltage - 115 V. or 230 V.

Line Current - 1.0 amp. at 115 V. or 0.5 amp. at 230 V.

##### b. D-C Operation. -

Storage battery voltage - 6 V.

\*Storage battery current drain - 4.5 amps. (Filament current only.)

"B" battery or vibrator supply voltage - 270 V.

"B" battery or vibrator supply current drain - 145 ma.

\* NOTE - When a vibrator supply operates from the storage battery the drain will run about 20-22 amperes.

#### 3. AUDIO POWER OUTPUT.

Speaker operation - 3 watts with less than 5% distortion (500 or 5000 ohms).

Headset operation - 3 watts with less than 5% distortion (600 ohms).

#### 4. SENSITIVITY.

At 30 mc. - 2.0 microvolts (For 50 milliwatt audio output).

At 135 mc. - 10.0 microvolts (For 50 milliwatt audio output).

(Signal generator modulated 30% at 400 cycles.)

#### 5. AUDIO FIDELITY.

Audio response is flat within  $\pm 3$  db. from 40 to 10,000 cycles per second.

#### 6. IMAGE RATIO.

Image ratio exceed 1000:1 at 30 mc., 300:1 at 58 mc.; 100:1 at 80 mc. and 60:1 at 100 mc.

#### 7. SELECTIVITY.

I-F selectivity measured at the grid of the mixer tube is not less than 10kc. or more than 25 kc. with the SELECTIVITY switch at SHARP and not less than 65 kc. or more than 80 kc. with the SELECTIVITY switch at BROAD. at 6 db. down from resonance.

#### 8. OVERALL WEIGHT.

Net 78 pounds.

#### 9. OVERALL DIMENSIONS.

Height 9-5/16 x width 19-1/8 x depth 15-3/4 (inches)

NOTE - Allow additional height of 11 inches to clear cover in top of cabinet.

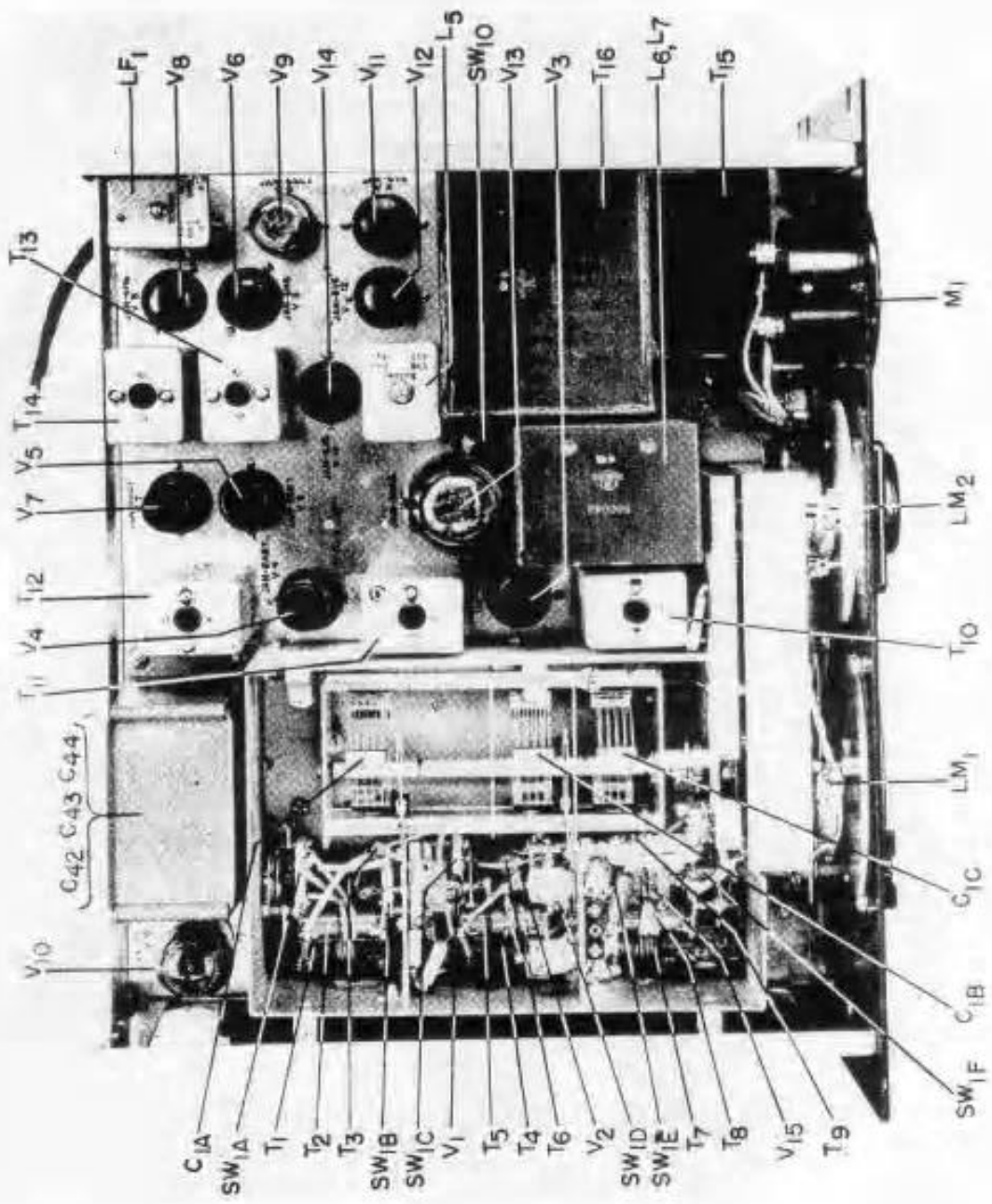
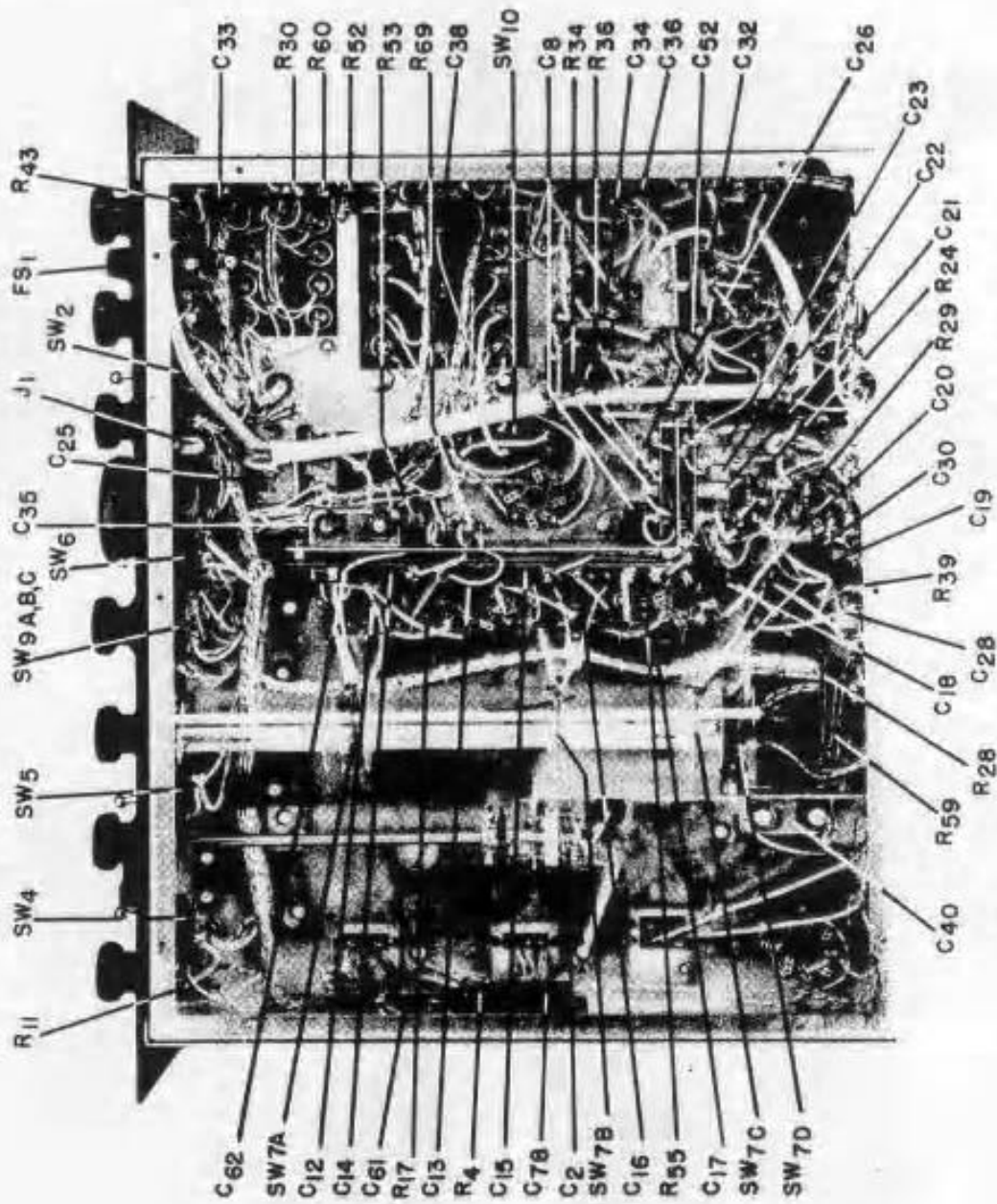

Figure 7-1. Radio Receiver Model 8-36A, top view.



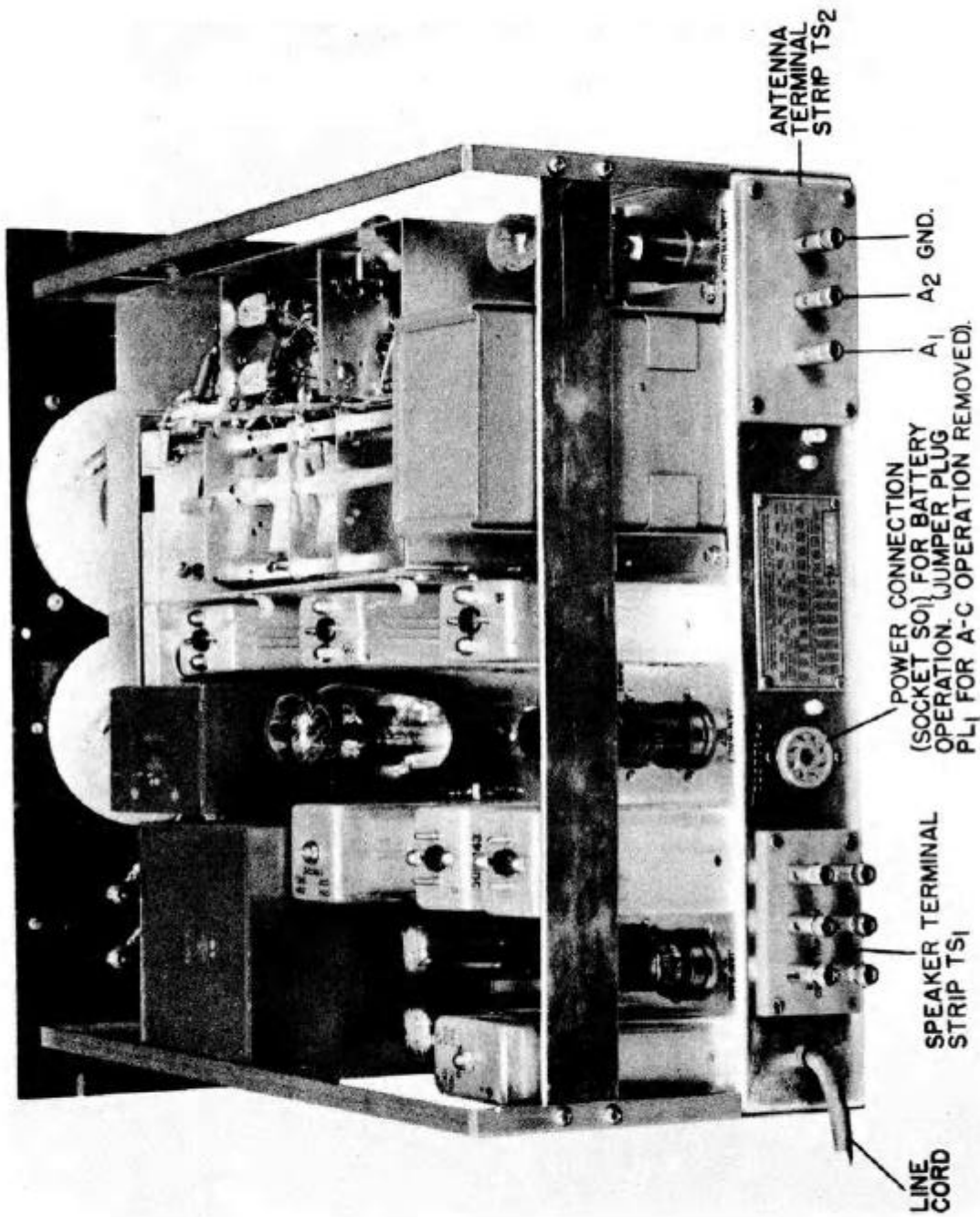

Figure 7-3. Radio Receiver Model S-36A, rear view.

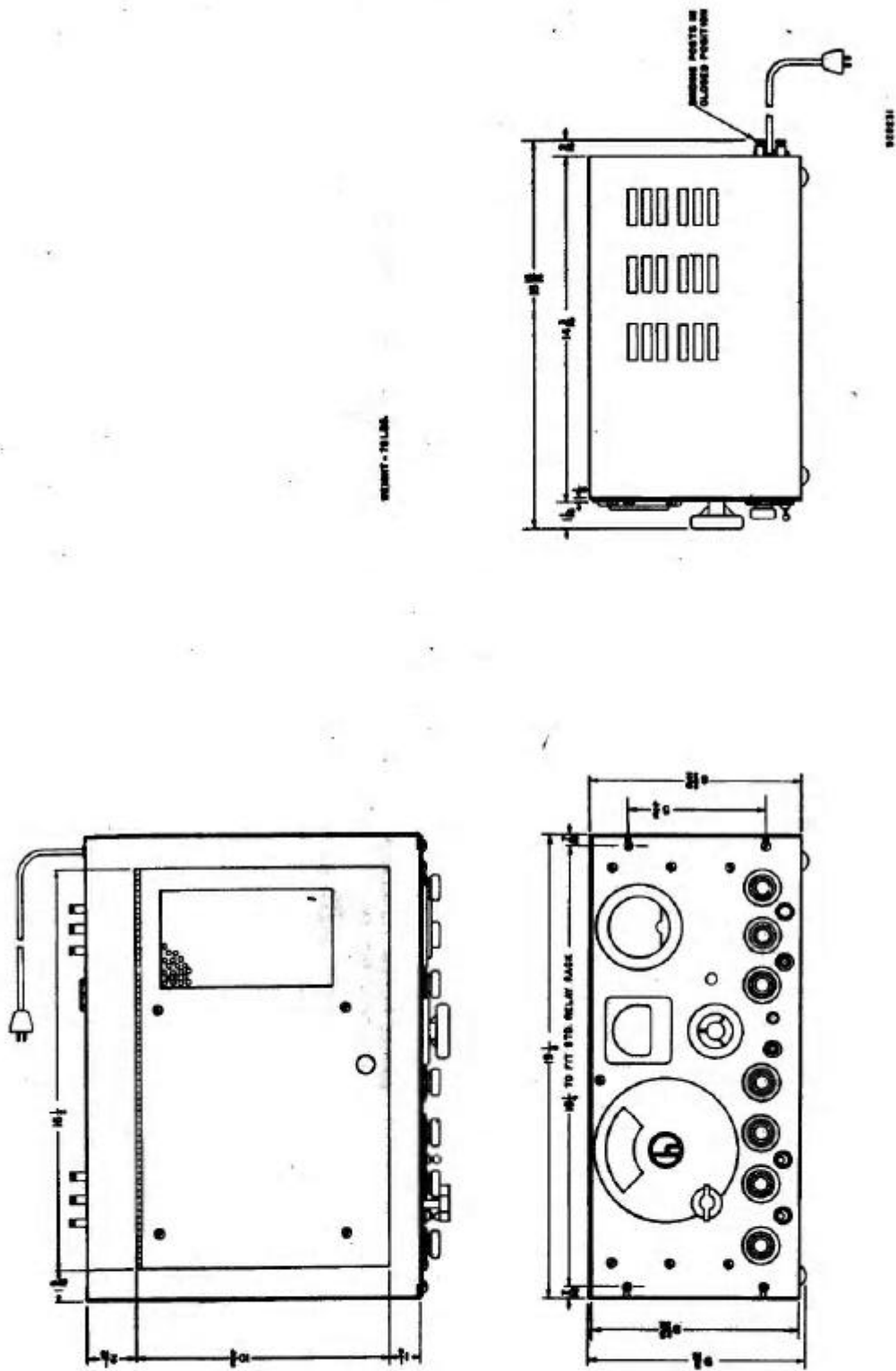
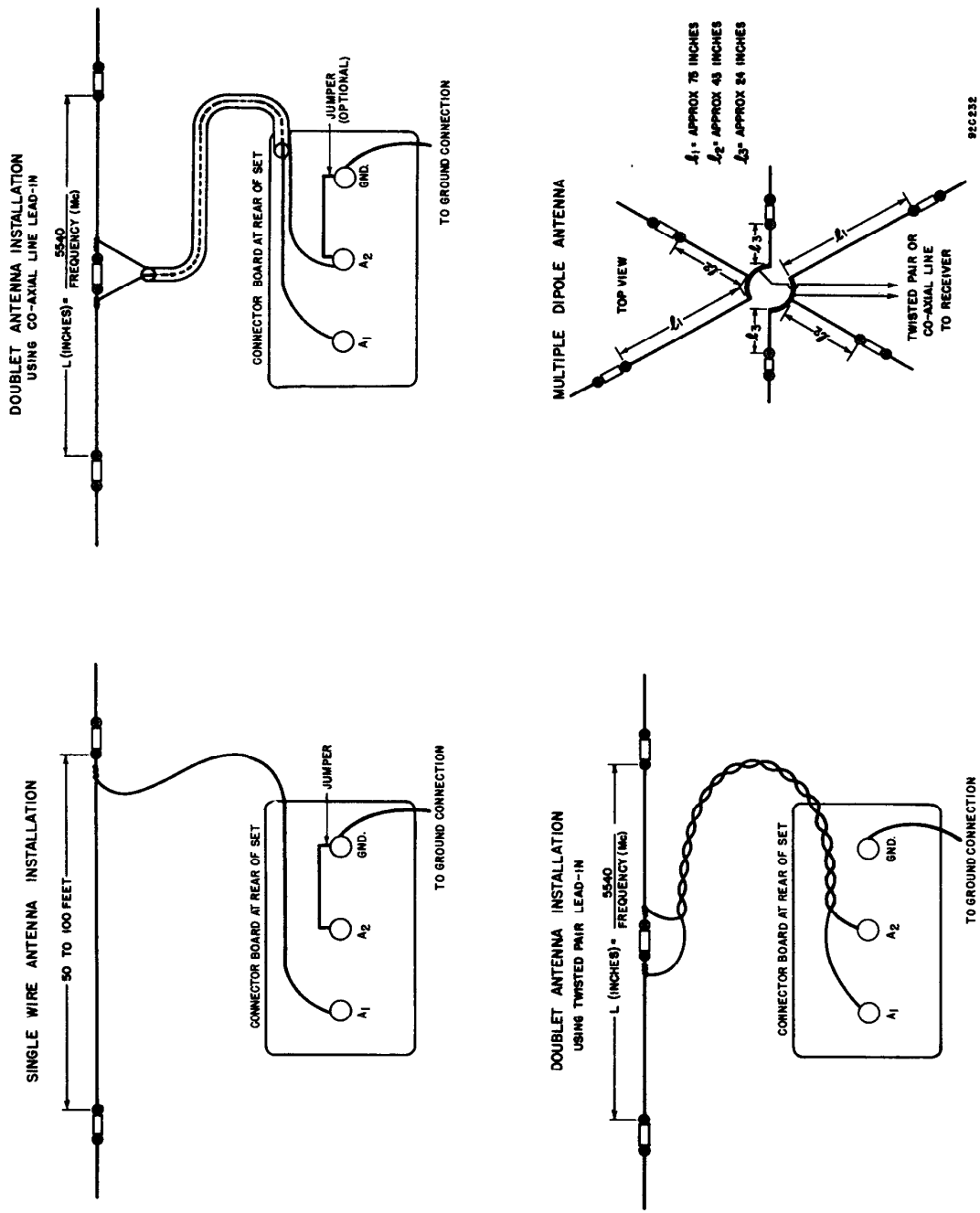

Figure 7-4. Radio Receiver Model S-364, outline dimensions.



95C232

Figure 7-5. Radio Receiver Model S-36A, recommended antenna installations.



### ACORN TYPE TUBES

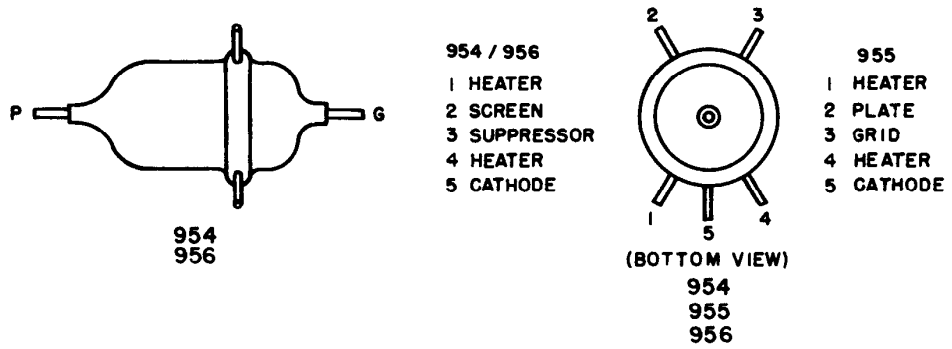

### STANDARD TYPE TUBES

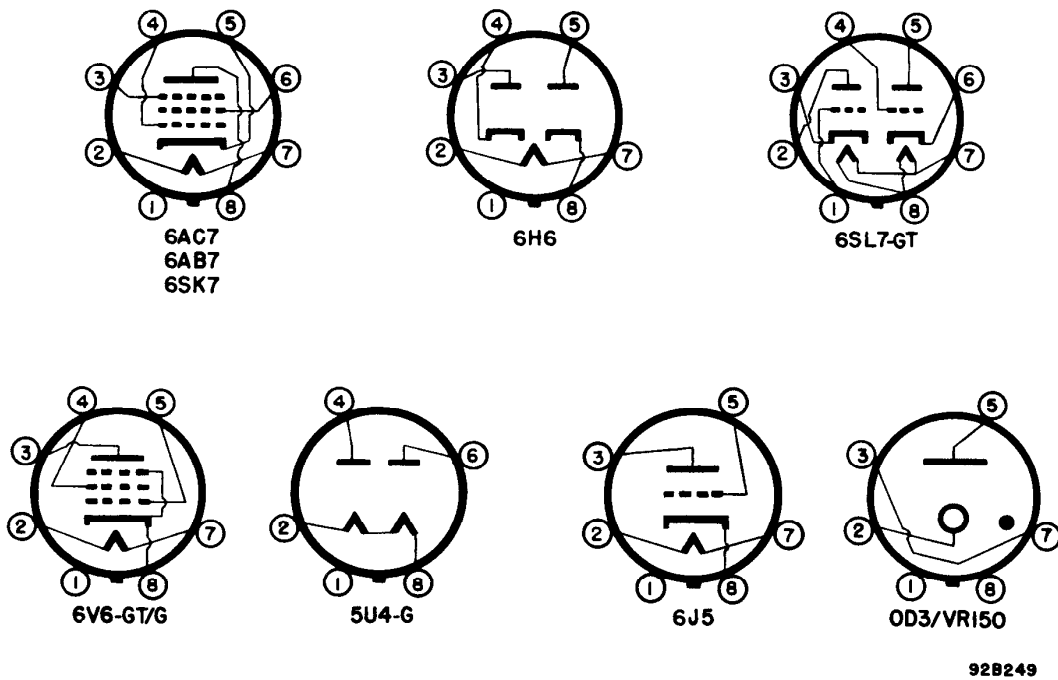

Figure 7-6. Radio Receiver Model S-36A, tube socket connections.

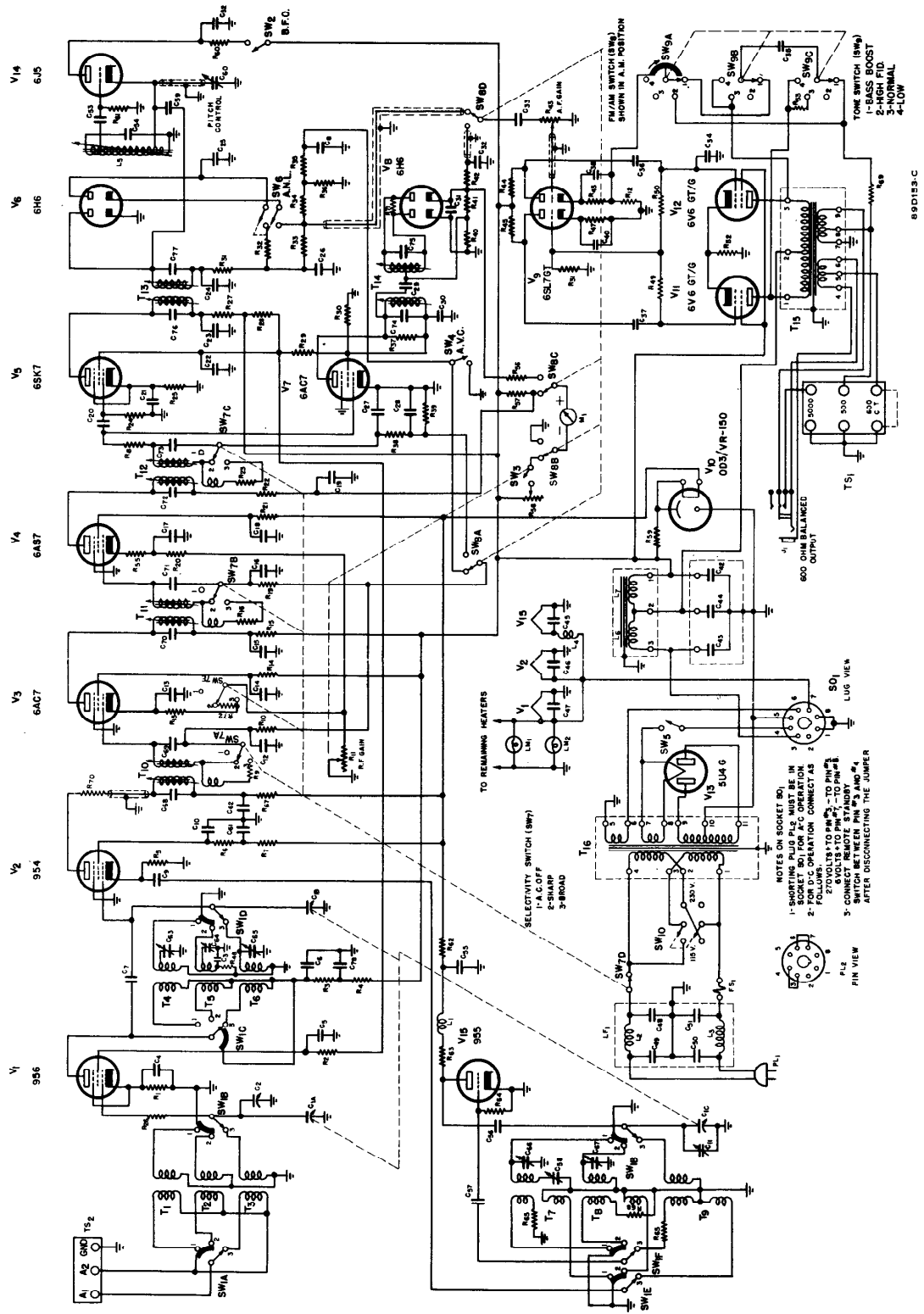

Figure 7-7. Radio Receiver Model S-36A, schematic wiring diagram.

MODEL S-36A PARTS LIST

Ref. Symbol	Name of Part and Description	Function	Mfr Code and Type No.	Hallicrafter's Part No.
CAPACITORS				
C <sub>1</sub>	Capacitor, variable: air dielectric; 3 section; 9 plates with double spacing between plates; min. cap, 6 mmfd., max. cap. 54.7 mmfd.; plates are aluminum; shaft silver plated brass 1/8" long x 0.375" dia., with x 2B insulation on stators; front rotor section grounded to frame, other two sections insulated from frame; spade lug mtg.; solder lug terminals.	Secondary tuning of transformers T <sub>1</sub> to T <sub>9</sub> inclusive	OM special	48C147
C <sub>2</sub>	Capacitor, variable: air dielectric; single section; 7 plates; min. cap. 3 mmfd., max. cap. 25 mmfd.; aluminum plates; ceramic insulation; brass shaft 3/4" long x 1/8" dia., mtg. base 1/8" thick x 1-7/32" dia., mtg. centers 21/32"; total depth of unit 7/8"; solder lug terminals	ANTENNA tuning	BC type 22-7	48A039
C <sub>3</sub>	Capacitor, fixed: mica dielectric; 330 mmfd. ± 10%; 500 V. D-C working; case 51/64" lg x 15/32" wd x 7/32" thk; same as C <sub>5</sub> , C <sub>9</sub> , C <sub>10</sub> , C <sub>45</sub> , C <sub>46</sub> , C <sub>47</sub> , C <sub>55</sub> .	Secondary padder on transformer T <sub>5</sub>	ASA	CM20A331K
C <sub>4</sub>	Capacitor, fixed: mica dielectric; 2200 mmfd. ± 10%; 500 V. D-C working; case 53/64" long x 53/64" wide x 9/32" thick; same as C <sub>6</sub> , C <sub>52</sub> , C <sub>61</sub> .	Cathode by-pass for tube V <sub>1</sub>	ASA	CM30A222K
C <sub>5</sub>	Same as C <sub>3</sub>	Screen by-pass for tube V <sub>1</sub>	-	-
C <sub>6</sub>	Same as C <sub>4</sub>	Plate return for tube V <sub>1</sub>	-	-
C <sub>7</sub>	Capacitor, fixed: ceramic dielectric; 10 mmfd. ± 10%; 500 V. D-C working; temp. coeff. -0.00055 mmfd./mmfd./deg. Cent.; case 0.625" long x 0.225" dia.	Coupling between tubes V <sub>1</sub> and V <sub>2</sub>	CRL type 811-077	47A006

		A-V-C filter	ASA	CM40A822K
C <sub>8</sub>	Capacitor, fixed: mica dielectric; 8200 mmfd. ± 10%; 500 V. D-C working; case 1-1/32" long x 41/64" wide x 11/32" thick; same as C <sub>13</sub> , C <sub>14</sub> , C <sub>15</sub> , C <sub>17</sub> , C <sub>18</sub> , C <sub>19</sub> , C <sub>21</sub> , C <sub>22</sub> , C <sub>23</sub> , C <sub>30</sub> , C <sub>33</sub> , C <sub>36</sub> , C <sub>37</sub> , C <sub>62</sub> , C <sub>78</sub> .	A-V-C filter		
C <sub>9</sub>	Same as C <sub>3</sub>	Coupling between oscillator tube V <sub>15</sub> and mixer tube V <sub>2</sub>	-	-
C <sub>10</sub>	Same as C <sub>3</sub>	Screen by-pass for tube V <sub>2</sub>	-	-
C <sub>11</sub>	Capacitor, variable: air dielectric; small variable capacity formed between a 6-32 metal screw and a CRS plate 5/8" wd x 13/16" lg, rolled to 3/16" ID, at one end, with a 7/32" dia mtg hole 3/16" center from other end x 7/32" center from top side; cadmium plated plate.	Trimmer adjustment for osc. tuning capacitor C <sub>1C</sub>	H 48A140	48A140
C <sub>12</sub>	Capacitor, fixed: paper dielectric; 1000 mmfd. + 100-20%; 600 V. D-C working; case 3/4" lg x 1/2" wd x 7/32" thk.	A-V-C filter for tube V <sub>3</sub>	CE	47A121
C <sub>13</sub>	Same as C <sub>8</sub>	Cathode by-pass for tube V <sub>3</sub>	-	-
C <sub>14</sub>	Same as C <sub>8</sub>	Screen by-pass for tube V <sub>3</sub>	-	-
C <sub>15</sub>	Same as C <sub>8</sub>	Plate return for tube V <sub>3</sub>	-	-
C <sub>16</sub>	Same as C <sub>12</sub>	A-V-C filter for tube V <sub>4</sub>	-	-
C <sub>17</sub>	Same as C <sub>8</sub>	Cathode by-pass for tube V <sub>4</sub>	-	-
C <sub>18</sub>	Same as C <sub>8</sub>	Screen grid by-pass for tube V <sub>4</sub>	-	-
C <sub>19</sub>	Same as C <sub>8</sub>	Plate return for tube V <sub>4</sub>	-	-
C <sub>20</sub>	Capacitor, fixed: mica dielectric; 47 mmfd. ± 10%; 500 V. D-C working; case 51/64" long x 15/32" wide x 7/32" thick; same as C <sub>31</sub> .	Coupling between transformer T <sub>12</sub> and Tube V <sub>5</sub>	ASA	CM20A470K
C <sub>21</sub>	Same as C <sub>8</sub>	Cathode by-pass for tube V <sub>5</sub>	-	-

MODEL S-36A PARTS LIST

Ref. Symbol	Name of Part and Description	Function	Mfr Code and Type No.	Hallcrafters Part No.
C <sub>22</sub>	Same as C <sub>8</sub>	Screen grid by-pass for tube V <sub>5</sub>	-	-
C <sub>23</sub>	Same as C <sub>8</sub>	Plate return for tube V <sub>5</sub>	-	-
C <sub>24</sub>	Capacitor, fixed; mica dielectric; 56 mmfd. ± 10%; 500 V. D-C working; case 51/64" long x 15/32" wide x 7/32"; thk; same as C <sub>26</sub>	Diode return for tube V <sub>6</sub>	ASA	CM20A560K
C <sub>25</sub>	Capacitor, fixed; paper dielectric; 0.05 mfd. - 6 + 14%; 600 V. D-C working; metal case 1-25/32" long x 1-1/32" deep x 13/16" high, with 2 mtg. feet with 2-1/8" mtg. centers; 2 solder lug terminals insulated from case by neoprene seals and phenolic washers; same as C <sub>35</sub>	A-N-L by-pass	IC type 7678	46A005
C <sub>26</sub>	Same as C <sub>24</sub>	Diode filter for tube V <sub>6</sub>	-	-
C <sub>27</sub>	Capacitor, fixed; mica dielectric; 100 mmfd. ± 10%; 500 V. D-C working; case 51/64" lg x 15/32" wd x 7/32" thick.	A-V-C filter	ASA	CM20A101K
C <sub>28</sub>	Capacitor, fixed; mica dielectric; 560 mmfd. ± 10%; 500 V. D-C working; case 53/64" long x 53/64" wide x 9/32" thick.	A-V-C filter	ASA	CM30A561K
C <sub>29</sub>	Capacitor, fixed; ceramic dielectric; 25 mmfd. ± 10%; 500 V. D-C working; negative 0 temp. coeff; body 5/8" lg x 3/16" dia.	Coupling between tube V <sub>7</sub> and transformer T <sub>14</sub>	IRC special	47A142
C <sub>30</sub>	Same as C <sub>8</sub>	Plate return for tube V <sub>7</sub>	-	-
C <sub>31</sub>	Same as C <sub>20</sub>	Cathode by-pass for tube V <sub>8</sub>	-	-
C <sub>32</sub>	Capacitor, fixed; mica dielectric; 560 mmfd. ± 10%; 500 V. D-C working; case 1-1/16" long x 15/32" wide x 7/32" thick.	De-emphasis for tube V <sub>8</sub>	ASA	CM25A561K

C <sub>33</sub>	Same as C <sub>8</sub>	Coupling between tubes V <sub>6</sub> , V <sub>8</sub> and V <sub>9</sub>	-	-
C <sub>34</sub>	Capacitor, fixed: mica dielectric; 1000 mmfd $\pm$ 10%; 500 V. D-C working; case 53/64" square x 9/32 thk.	Grid by-pass for tube V <sub>12</sub>	ASA	CM30A102K
C <sub>35</sub>	Same as C <sub>25</sub>	Tone control for tubes V <sub>11</sub> and V <sub>12</sub>	-	-
C <sub>36</sub>	Same as C <sub>8</sub>	Coupling between tubes V <sub>9</sub> and V <sub>12</sub>	-	-
C <sub>37</sub>	Same as C <sub>8</sub>	Coupling between tubes V <sub>9</sub> and V <sub>11</sub>	-	-
C <sub>38</sub>	Capacitor, fixed: paper dielectric; 20 mfd. - 10 + 75%; 25 V. D-C working; case hermetically sealed metal 2-1/8" long x 1" deep x 13/16" high; 2 mtg. feet with 2-1/8" mtg. centers; 2 solder lug terminals insulated from the case; same as C <sub>40</sub>	Cathode by-pass for tube V <sub>9</sub>	IC type 1B113	46A011
C <sub>39</sub>	Capacitor, fixed: mica dielectric; 150 mmfd. $\pm$ 10%; 500 V. D-C working; case 51/64" lg x 15/32" wd x 7/32" thk	Tone control for tubes V <sub>11</sub> and V <sub>12</sub>	ASA	CM20A151K
C <sub>40</sub>	Same as C <sub>38</sub>	Cathode by-pass for tube V <sub>9</sub>	-	-
C <sub>41</sub>	Not used			
C <sub>42</sub>	Capacitor, fixed: paper dielectric; triple unit; unit #1 is 4 mfd. 650 V. D-C working (C <sub>42</sub> ), unit #2 is 8 mfd. 650 V. D-C working (C <sub>43</sub> ), unit #3 is 8 mfd. 650 V. D-C working (C <sub>44</sub> ); hermetically sealed metal case 4-1/2" long x 2-3/8" deep x 5-7/16" high; 2 mtg. feet with 4-3/4" x 2" mtg. centers; 4 solder lug terminals (one common to all units) insulated from the case by bakelite and neoprene washers; terminals marked "8", "4", "8".	Power supply filter	IC type 7392E	42B043
C <sub>43</sub>				
C <sub>44</sub>				
C <sub>45</sub>	Same as C <sub>3</sub>	Heater by-pass for tube V <sub>15</sub>	-	-
C <sub>46</sub>	Same as C <sub>3</sub>	Heater by-pass for tube V <sub>2</sub>	-	-
C <sub>47</sub>	Same as C <sub>3</sub>	Heater by-pass for tube V <sub>1</sub>	-	-

MODEL S-36A PARTS LIST

Ref. Symbol	Name of Part and Description	Function	Mfr Code and Type No.	Hallcrafters Part No.
C48	Capacitor, fixed: mica dielectric; 8200 mmfd $\pm$ 20%; 500 V. D-C working; case 53/64" square x 11/32" thk; same as C49, C50, C51.	Power line filter in LF <sub>1</sub>	ASA	CM35A822M
C49	Same as C48	Power line filter in LF <sub>1</sub>	-	-
C50	Same as C48	Power line filter in LF <sub>1</sub>	-	-
C51	Same as C48	Power line filter in LF <sub>1</sub>	-	-
C52	Same as C4	Plate decoupling for tube V <sub>14</sub>	-	-
C53	Capacitor, fixed: mica dielectric; 100 mmfd $\pm$ 20%; 500 V. D-C working; case 51/64" lg x 15/32" wd x 7/32" thk.	B-F-O grid coupling	ASA	CM20A101K
C54	Capacitor, fixed: ceramic dielectric; 200 mmfd $\pm$ 10%; 500 V. D-C working; zero temp. coeff; body 1.875" lg x 0.265" dia.	B-F-O tuning on L <sub>5</sub>	ER	47A026
C55	Same as C <sub>3</sub>	Plate decoupling for tube V <sub>15</sub>	-	-
C56	Capacitor, fixed: ceramic dielectric; 50 mmfd $\pm$ 2.5 mmfd; 500 V. D-C working; neg. 0.00075 mmfd/mmfd/deg. Cent.; body 7/16" lg x 7/32" dia.	Plate decoupling for tube V <sub>15</sub>	ER type N750K	47A109
C57	Capacitor, fixed: ceramic dielectric; 1000 mmfd $\pm$ 20%; 500 V. D-C working; body 11/16" lg x 3/16" dia.	Grid coupling for tube V <sub>15</sub>	MT type 20KI200	47A132
C58	Capacitor, adjustable: mica dielectric; 450 mmfd $\pm$ 10%; bakelite mtg. insulation; 2 solder lug terminals to which are attached #18AWG tinned copper leads 1" long, both leads insulated from the frame; special L shaped mtg. frame 1" x 7/8" x 1"; octagon condenser frame 3/4" diam.	Padder for transformer T <sub>7</sub>	UE type S81A	44A050

C59	Capacitor, fixed: twisted pair of leads to form 1 mmfd capacity.	Coupling between tubes V <sub>14</sub> and V <sub>6</sub>	-	-
C60	Capacitor, variable: air dielectric; min. cap. 3.5 mmfd, max. cap. 23 mmfd; ceramic insulation; 2 mtg. holes with 21/32" mtg. centers; one solder lug terminal (rotor plates); wire slot on stator plates mtg. posts; shaft 29/32" long x 1/4" dia.; base 1-7/32" long x 15/16" wide; overall depth 2-3/8".	Pitch control for tube T <sub>14</sub>	RC type 22-7	48A064
C61	Same as C <sub>4</sub>	Screen grid by-pass for tube V <sub>2</sub>	-	-
C62	Same as C <sub>8</sub>	Plate decoupling for tube V <sub>2</sub>	-	-
C63	Capacitor, adjustable: mica dielectric; min. cap. 3 mmfd, max. cap. 50 mmfd; ceramic insulation; compression type adjustment; unit is 3/4" long x 5/8" wide x 11/16" deep including 2 solder lug terminals.	Secondary trimmer for transformer T <sub>4</sub>	UE Special	44A049
C64	Capacitor, adjustable: ceramic dielectric; 4 to 20 mmfd; 300 V. D-C working; screw driver adjustment; vertically mounted by a CRS special mtg bracket; same as C <sub>65</sub> .	Secondary trimmer for transformer T <sub>5</sub>	H Special	44A101
C65	Same as C <sub>64</sub>	Secondary trimmer for transformer T <sub>6</sub>	-	-
C66	Capacitor, adjustable: air dielectric; 1 to 12 mmfd; bakelite insulation; screw driver adjustment; 1-11/64" lg x 0.555" dia. overall excluding solder lug terminals; same as C <sub>67</sub> .	Secondary trimmer for transformer T <sub>7</sub>	MN type 22-5230 modified	44A140
C67	Same as C <sub>66</sub>	Secondary trimmer for transformer T <sub>8</sub>	-	-
C68	Capacitor, fixed: ceramic dielectric; 100 mmfd ± 3%; 500 V. D-C working; neg. 0.00005 mmfd temp. coeff.; body 3/4" lg x 1/4" dia.; same as C <sub>69</sub> , C <sub>70</sub> , C <sub>71</sub> , C <sub>72</sub> , C <sub>73</sub> , C <sub>76</sub> , C <sub>77</sub> .	Primary trimmer for transformer T <sub>10</sub>	ER Special	47A117



MODEL S-36A PARTS LIST

Ref. Symbol	Name of Part and Description	Function	Mfr Code and Type No.	Hallcrafters Part No.
C69	Same as C68	Secondary trimmer for transformer T <sub>10</sub>	-	-
C70	Same as C68	Primary trimmer for transformer T <sub>11</sub>	-	-
C71	Same as C68	Secondary trimmer for transformer T <sub>11</sub>	-	-
C72	Same as C68	Primary trimmer for transformer T <sub>12</sub>	-	-
C73	Same as C68	Secondary trimmer for transformer T <sub>12</sub>	-	-
C74	Capacitor, fixed: ceramic dielectric; 50 mmfd ± 10%; 500 V. D-C working; zero temp. coeff; body 3/4" lg x 1/4" dia.; same as C75.	Primary trimmer for transformer T <sub>14</sub>	ER Special	47A091
C75	Same as C74	Secondary trimmer for transformer T <sub>14</sub>	-	-
C76	Same as C74	Primary trimmer for transformer T <sub>13</sub>	-	-
C77	Same as C74	Secondary trimmer for transformer T <sub>13</sub>	-	-
C78	Same as C8	Plate decoupling for tube V <sub>1</sub>	-	-
<b>FUSES</b>				
FS <sub>1</sub>	Fuse: 3 amperes @250 V.; 4AG; glass enclosed; 1-3/4" long x 9/32" dia.; caps nickel plated copper alloy; carries 110% of rated current; vibration factor is 200.	Power transformer primary protection	LF type 1083	39A318

JACKS

J <sub>1</sub>	Jack, phone: switching-one make, one break; steel frame; silver contacts; rubber and bakelite insulation; mounted by 3/8-32 brass bushing 1/2" long; frame dimensions 1-19/32" x 27/32" x 3/4"; solder lug contacts; 1" from front of bushing to tip contact.	600 ohm headset connector.	U type ST-687 modified	36B008
----------------	---	----------------------------	---------------------------------	--------

INDUCTORS

L <sub>1</sub>	Inductor, R-F: 75 turns of #38SCE single layer winding; inductance 15.5 microhenries ± 10%; d-c resistance 4.10 ohms ± 3%; wound on molded bakelite coil form 15/16" long x 5/32" dia., coated with Chinese red lacquer; air core.	Plate choke for tube V <sub>15</sub>	SWI type 661	53A008
L <sub>2</sub>	Inductor, line filter: 57 turns of #28SCE universal winding; 46 microhenries inductance; winding 1/2" ID x 1-1/16" OD x 9/32" lg; air core; coil form 1" lg x 1/2" dia., tapped 6-32 at each end for mtg.	Power line filter choke	H 53A062	53A082
L <sub>3</sub> L <sub>4</sub>	Same as L <sub>2</sub> Inductor, R-F: 42 turns of #28SCE single layer winding; inductance 4.20 microhenries ± 10%; d-c resistance 0.25 ohms ± 70%; wound on molded bakelite coil form 7/8" long x 9/32" dia., coated with Chinese blue lacquer; air core.	Power line filter choke Choke for heater of tube V <sub>15</sub>	- SWI type 662	- 53A008
L <sub>5</sub>	Inductor, beat frequency oscillator: 15-7/8 turns of #15/44 D cel. litz single layer winding tapped 3-1/S" turns and 10-7/8 turns from start of winding; coil wound on xx bakelite tube 1-5/8" long x 1/2" O.D. x 0.409" I.D.; tuned by adjustable iron core; unit shielded; assembly includes resistor R <sub>61</sub> and capacitors C <sub>53</sub> , C <sub>54</sub> , and C <sub>59</sub> .	Beat frequency oscillator (B-F-O) coil	SWI type 3491	54C024

MODEL S-36A PARTS LIST

Ref. Symbol	Name of Part and Description	Function	Mfr Code and Type No.	Hallcrafters Part No.
L <sub>6</sub> L <sub>7</sub>	Inductor assembly, filter: 2 section unit; section #1 inductance 3 henries - 10 + 30% @ 150 milliamperes; d-c resistance 85 ohms ± 10%; connected to solder lug terminals #2 and #3 (L <sub>6</sub> ); section #2 inductance 12 henries - 10 + 20%, @ 90 milliamperes; d-c resistance 215 ohms ± 10%; connected to solder lug terminals #1 and #2 (L <sub>7</sub> ); each section has a separate iron core; coils and cores located so no mutual coupling exists; hermetically sealed case 3- $\frac{1}{4}$ " long x 2-9/16" deep x 5- $\frac{1}{2}$ " high; unit mounts by 4 threaded lugs with 2-5/8" x 1-9/16" mtg. centers; breakdown between core and windings 2000 V. RMS; heat rise under rated load 40 deg. Cent. or less	Power supply filter choke	ST type 10CU23	56C048
LINE FILTERS				
LF <sub>1</sub>	Line filter assembly: consists of inductors L <sub>2</sub> and L <sub>3</sub> , and capacitors C <sub>48</sub> , C <sub>49</sub> , C <sub>50</sub> and C <sub>51</sub> , mounted in drawn aluminum can 4-15/32" high, x 1-3/8" wide x 1-13/16" deep with solder lug terminals and mounted by 4 spade lugs.	A-C line filter	SWI type 3492	53A056
LAMPS				
LM <sub>1</sub>	Lamp: bayonet base 6 to 8 volts @ 250 milliamperes; glass bulb; same as LM <sub>2</sub>	Main tuning dial lamp	GE type 44	39A003
LM <sub>2</sub>	Same as LM <sub>1</sub>	Vernier tuning dial lamp	-	-

METERS

M <sub>1</sub>	Meter, "S" meter; calibrated in "S" units; 160-0-40 micro-amperes movement; body 2.82" dia. x 1.50" deep; round flush type mg. plate 3.5 O.D., with 3 mtg. holes 120 degrees apart; includes 2 terminals ±28-NF2 which project 0.69" from rear of meter.	A.M./F.M. tuning meter	H Special	82A097
----------------	--	------------------------	--------------	--------

PLUGS

PL <sub>1</sub>	Plug and line cord assembly: 2 conductor #18 type S-J all rubber covered cord 6 feet long with a spring type (al- lied type 371) molded on plug at one end and stripped and tinned for 5/8" at the other end.	A-C power line connection	B type 1750	87A125
PL <sub>2</sub>	Plug, octal; male, bakelite body 1- $\frac{1}{8}$ " O.D. x 7/16" thick; metal contact prongs 7/16" long; supplied with insulated jumpers between contacts 3 and 4, and contacts 6 and 7.	Shorting plug for A-C operating and remote stand-by connection	AP type CP-8	35A003

RESISTORS

R <sub>1</sub>	Resistor, fixed: 270 ohms ± 10%; $\frac{1}{2}$ watt; carbon; insulated; 0.249" O.D. x 0.655" long.	Cathode bias for tube V <sub>1</sub>	ASA	RC21AE271K
R <sub>2</sub>	Resistor, fixed: 1000 ohms ± 10%; $\frac{1}{2}$ watt; carbon; insulated; 0.249" O.D. x 0.655" long; same as R <sub>3</sub> , R <sub>6</sub> , R <sub>21</sub> , R <sub>27</sub> , R <sub>67</sub> .	Screen voltage dropping for tube V <sub>1</sub>	ASA	RC21AE102K
R <sub>3</sub>	Same as R <sub>2</sub>	Plate decoupling for tube V <sub>1</sub>	-	-
R <sub>4</sub>	Resistor, fixed: 10,000 ohms ± 20%; 2 watt; carbon; insulated; 0.342" O.D. x 1.76" long.	Plate decoupling for tube V <sub>1</sub>	ASA	RC41AE103M
R <sub>5</sub>	Resistor, fixed: 2300 ohms ± 10%; $\frac{1}{2}$ watt; carbon; insulated; 0.249" O.D. x 0.655" long; same as R <sub>29</sub> , R <sub>72</sub> .	Cathode bias for tube V <sub>2</sub>	ASA	RC21AE222K

MODEL S-36A PARTS LIST

Ref. Symbol	Name of Part and Description	Function	Mfr Code and Type No.	Hallcrafters Part No.
R <sub>6</sub>	Same as R <sub>2</sub>	Screen voltage dropping for tube V <sub>2</sub>	-	-
R <sub>7</sub>	Resistor, fixed: 100,000 ohms $\pm$ 10%; $\frac{1}{2}$ watt; carbon; insulated; 0.249" O.D. x 0.655" long; same as R <sub>33</sub> , R <sub>40</sub> , R <sub>41</sub> , R <sub>51</sub> .	Screen voltage dropping for tube V <sub>2</sub>	ASA	RC21AE104K
R <sub>8</sub>	Not used			
R <sub>9</sub>	Resistor, fixed: 10 ohms $\pm$ 10%; $\frac{1}{2}$ watt; carbon; insulated; 0.249" O.D. x 0.655" long; same as R <sub>16</sub> , R <sub>23</sub> , R <sub>26</sub> .	1st I-F band expansion on transformer T <sub>10</sub>	ASA	RC21AE100K
R <sub>10</sub>	Resistor, fixed: 100,000 ohms $\pm$ 10%; $\frac{1}{2}$ watt; carbon; insulated; 0.170" diam x 0.406" long.	A-V-C decoupling for tube V <sub>3</sub>	ASA	RC10AE104K
R <sub>11</sub>	Resistor, variable: 10,000 ohm $\pm$ 20%; #8 reversed taper; shaft 1" long x $\frac{1}{8}$ " dia.; 3 solder lug terminals with the variable contact located in the center and the fixed contacts 1-7/16" apart; no taps; includes a toggle action switch (SW <sub>3</sub> ) on rear which closes the circuit when the control is turned to the extreme right (clockwise).	R.F. GAIN control	CT type 135	25C068G
R <sub>12</sub>	Resistor, fixed: 120 ohms $\pm$ 10%; $\frac{1}{2}$ watt; carbon; insulated; 0.249" O.D. x 0.468" long.	Cathode bias for tube V <sub>9</sub>	ASA	RC20AE121K
R <sub>13</sub>	Resistor, fixed: 120 ohms $\pm$ 10%; $\frac{1}{2}$ watt; carbon; insulated; 0.249" O.D. x 0.655" long; same as R <sub>20</sub> .	Cathode bias for tube V <sub>3</sub>	ASA	RC21AE121K
R <sub>14</sub>	Resistor, fixed: 39,000 ohms $\pm$ 10%; $\frac{1}{2}$ watt; carbon; insulated; 0.249" O.D. x 0.655" long.	Screen voltage dropping for tube V <sub>3</sub>	ASA	RC21AE393K
R <sub>15</sub>	Resistor, fixed: 330 ohms $\pm$ 10%; $\frac{1}{2}$ watt; carbon; insulated; 0.249" O.D. x 0.655" long; same as R <sub>22</sub> , R <sub>25</sub> , R <sub>32</sub> .	Plate decoupling for tube V <sub>3</sub>	ASA	RC21AE331K

R <sub>16</sub>	Same as R <sub>9</sub>	2nd I-F band expansion on transformer T <sub>11</sub>	-	-
R <sub>17</sub>	Not used.			
R <sub>18</sub>	Resistor, fixed: 33 ohms $\pm$ 10%; $\frac{1}{2}$ watt; carbon; insulated; 0.249" O.D. x 0.655" long; same as R <sub>55</sub> , R <sub>57</sub> , R <sub>65</sub> .	Parasitic suppressor for tube V <sub>5</sub>	ASA	RC21AE30K
R <sub>19</sub>	Same as R <sub>10</sub>	A-V-C decoupling for tube V <sub>4</sub>	-	-
R <sub>20</sub>	Same as R <sub>13</sub>	Cathode bias for tube V <sub>4</sub>	-	-
R <sub>21</sub>	Same as R <sub>2</sub>	Screen voltage dropping for tube V <sub>4</sub>	-	-
R <sub>22</sub>	Same as R <sub>15</sub>	Plate decoupling for Tube V <sub>4</sub>	-	-
R <sub>23</sub>	Same as R <sub>9</sub>	3rd I-F band expansion on transformer T <sub>12</sub>	-	-
R <sub>24</sub>	Resistor, fixed: 470,000 ohms $\pm$ 10%; $\frac{1}{2}$ watt; carbon; insulated; 0.249" O.D. x 0.655" long; same as R <sub>35</sub> , R <sub>56</sub> .	Grid return for tube V <sub>5</sub>	ASA	RC21AE474K
R <sub>25</sub>	Same as R <sub>15</sub>	Cathode bias for tube V <sub>5</sub>	-	-
R <sub>26</sub>	Same as R <sub>9</sub>	Parasitic suppressor for tube V <sub>1</sub>	-	-
R <sub>27</sub>	Same as R <sub>2</sub>	Plate decoupling for tube V <sub>5</sub>	-	-
R <sub>28</sub>	Resistor, fixed: 7500 ohms $\pm$ 5%; 10 watt; wire wound; coated with baked vitreous enamel; 3/8" O.D. x 1-3/4" long.	Screen voltage dropping for tubes V <sub>1</sub> , V <sub>5</sub> and V <sub>7</sub>	IRC type AB	24B6752D
R <sub>29</sub>	Same as R <sub>5</sub>	Screen and plate voltage dropping for tube V <sub>7</sub>	-	-
R <sub>30</sub>	Resistor, fixed: 22,000 ohms $\pm$ 10%; 2 watt; carbon; insulated; 0.342" O.D. x 1.76" long; same as R <sub>60</sub> .	Screen voltage divider for tube V <sub>7</sub>	ASA	RC41AE223K
R <sub>31</sub>	Resistor, fixed: 47,000 ohms $\pm$ 10%; $\frac{1}{2}$ watt; carbon; insulated; 0.249" O.D. x 0.655" long.	Diode load for tube V <sub>6</sub>	ASA	RC21AE473K

MODEL S-36A PARTS LIST

Ref. Symbol	Name of Part and Description	Function	Mfr Code and Type No.	Hallcrafters Part No.
R32	Resistor, fixed: 1 megohm $\pm$ 10%; $\frac{1}{2}$ watt; carbon; insulated; 0.249" O.D. x 0.655" long.	A-N-L load	ASA	RC21AE105K
R33	Same as R7	Diode load for tube V6	-	-
R34	Resistor, fixed: 220,000 ohms $\pm$ 10%; $\frac{1}{2}$ watt; carbon; insulated; 0.249" O.D. x 0.655" long; same as R36, R38, R42, R44, R45, R49, R50.	Diode load for tube V6	ASA	RC21AE224K
R35	Same as R24	A-V-C decoupling	-	-
R36	Same as R34	Diode load for tube V6	-	-
R37	Resistor, fixed: 15,000 ohms $\pm$ 10%; $\frac{1}{2}$ watt; carbon; insulated; 0.249" O.D. x 0.655" long; same as R71.	Primary load for discriminator transformer T14	ASA	RC21AE153K
R38	Resistor, fixed: 56,000 ohms $\pm$ 10%; $\frac{1}{2}$ watt; carbon, insulated; 0.249" O.D. x 0.655" long.	Grid return for tube V7	ASA	RC21AE563K
R39	Same as R34	Grid return for tube V7	-	-
R40	Same as R7	Diode load for tube V8	-	-
R41	Same as R7	Diode load for tube V8	-	-
R42	Same as R34	De-emphasis network for tube V8	-	-
R43	Resistor, variable: 1 megohm $\pm$ 20%; carbon; #6 taper; shaft 1" long x $\frac{1}{4}$ " dia.; 3 solder lug terminals with the variable contact located in the center and the fixed contacts 1-7/16" apart; no taps.	A.F. GAIN control	CT type 125	256059
R44	Same as R34	Plate load for tube V9	-	-
R45	Same as R34	Plate load for tube V9	-	-
R46	Resistor, fixed: 3300 ohms $\pm$ 10%; $\frac{1}{2}$ watt; carbon; insulated; 0.249" O.D. x 0.655" long; same as R47.	Cathode bias for tube V9	ASA	RC21AE332K

R47 R48	Same as R46 Resistor, fixed: 100,000 ohms $\pm$ 20%; $\frac{1}{2}$ watt; carbon; insulated; 0.249" diam x 0.655" long.	Cathode bias for tube V <sub>9</sub> Grid bias for tube V <sub>2</sub> on band 2	- ASA	- RC21AE104M
R49 R50 R51 R52	Same as R34 Same as R34 Same as R7 Resistor, fixed: 220 ohms $\pm$ 10%; 2 watt; carbon; insulated; 0.342" O.D. x 1.76" long.	Grid return for tube V <sub>11</sub> Grid return for tube V <sub>12</sub> Grid return for tube V <sub>9</sub> Cathode bias for tubes V <sub>11</sub> and V <sub>12</sub>	- - - ASA	- - - RC41AE221K
R53	Resistor, fixed: 3900 ohms $\pm$ 10%; 2 watt; carbon; insulated; 0.405" diam x 1.41" long.	Tone control feed back impedance	ASA	RC40AE392K
R54 R55 R56 R57 R58	Not used Same as R17 Same as R24 Same as R17 Resistor, variable: 1500 ohms $\pm$ 20%; wire wound; st. line taper; shaft 3/8" long x $\frac{1}{8}$ " dia. slotted 1/16" x 1/16"; 3 solder lug terminals with the variable contact located in the center and the fixed contacts 1-7/16" apart; no taps.	Degeneration for tube V <sub>4</sub> "S" meter current limiting "S" meter shunt "S" meter "0" setting control	- - - CT type 125	- - - 25C060
R59	Resistor, fixed: 3300 ohms $\pm$ 5%; 10 watt; wire wound; coated with baked vitreous enamel; 3/8" O.D. x 1-3/4" long.	Voltage dropping for tube V <sub>10</sub>	IRC type AB	24RG332D
R60 R61	Same as R30 Resistor, fixed: 47,000 ohms $\pm$ 10%; $\frac{1}{2}$ watt; carbon; insulated; 0.249" diam x 0.469" long.	Plate decoupling for tube V <sub>14</sub> Grid return for tube V <sub>14</sub>	- ASA	- RC20AE473K
R62	Same as R15	Plate decoupling for tube V <sub>15</sub>	-	-



MODEL S-36A PARTS LIST

Ref. Symbol	Name of Part and Description	Function	Mfr Code and Type No.	Hallcrafters Part No.
R <sub>63</sub>	Resistor, fixed: 4700 ohms $\pm$ 10% $\frac{1}{2}$ watt; carbon; insulated; 0.249" diam x 0.655" long.	Plate decoupling for tube V <sub>15</sub>	ASA	RC21AE472K
R <sub>64</sub>	Resistor, fixed: 22,000 ohms $\pm$ 10%; $\frac{1}{2}$ watt; carbon; insulated; 0.249" O.D. x 0.655" long.	Grid return for tube V <sub>15</sub>	ASA	RC21AE223K
R <sub>65</sub>	Same as R <sub>17</sub>	Grid current limiter for tube V <sub>15</sub>	-	-
R <sub>66</sub>	Resistor, fixed: 6 ohms $\pm$ 10%; $\frac{1}{2}$ watt; carbon; insulated; 0.215" O.D. x 7/16" long.	Grid current limiter for tube V <sub>15</sub>	ER type 504	23A011
R <sub>67</sub>	Same as R <sub>2</sub>	Plate decoupling for tube V <sub>2</sub>	-	-
R <sub>68</sub>	Resistor, fixed: 8 ohms $\pm$ 10%; $\frac{1}{2}$ watt; carbon; insulated; 0.215" O.D. x 7/16" long.	Grid current limiter for tube V <sub>15</sub>	ER type 504	23A019
R <sub>69</sub>	Resistor, fixed: 15,000 ohms $\pm$ 20%; $\frac{1}{2}$ watt; insulated; 0.249" diam x 0.406" long.	Tone control feed back impedance	ASA	RC20AE153N
R <sub>70</sub>	Same as R <sub>52</sub> .	Parasitic suppressor for tube V <sub>2</sub>	-	-
R <sub>71</sub>	Same as R <sub>37</sub> .	Secondary load for discriminator transformer T <sub>14</sub>	-	-
R <sub>72</sub>	Same as R <sub>5</sub> .	Degeneration for tube V <sub>3</sub>	-	-

SOCKETS			
SO <sub>1</sub>	Socket, octal; female; high dielectric mica filled bakelite body 1-7/64" dia. x 31/64" thick; silver plated phosphor bronze solder lugs; molded on steel mtg. plate 1-9/32" wide x 0.031 thick having 2 mtg. holes of 5/32" dia. x 1-3/8" mtg. centers; pins are numbered on back of socket clockwise from locating pin.	D-C power input and remote stand-by connection	AP type MIP67M
			6A200
SWITCHES			
SW <sub>1</sub>	Switch, rotary selector: 3 position single pole, 7 section; non-shortng type contacts; ceramic wafers oval shaped 1-7/8" x 1-5/8" x 5/32" thick; 2 holes 0.144" dia. x 1-9/16" mtg. centers mount wafers individually; entire shaft 11-3/4" long x 0.249" dia. squared on opposite sides to 0.185" dia., with index plate 1-7/8" x 1-3/8" x 0.038" thick and having two 0.1875" stainless steel balls; 3 stops, each 60 degrees apart and position 1 symmetrical to mtg. holes; minimum torque not less than 70 inch ounces.	BAND SWITCH	OM type HC
SW <sub>2</sub>	Switch, toggle: SPST; rated 3 amperes @ 250 V.; case 1" long threaded 15/32-32; solder lug contacts; same as SW <sub>4</sub> , SW <sub>5</sub> .	B.F.O. switch	CH type 8280
SW <sub>3</sub>	Switch, toggle action; SPST; part of resistor R <sub>68</sub>	"S" meter switch	-
SW <sub>4</sub>	Same as SW <sub>2</sub>	A.V.C. switch	-
SW <sub>5</sub>	Same as SW <sub>2</sub>	REC./SEND switch	-
SW <sub>6</sub>	Switch, toggle: DPST; rated 3 amperes @ 250 V.; case 1-3/32" long x 17/32" wide x 9/16" deep; mounted by bushing 15/32" long threaded 15/32-32; solder lug contact-	A.N.L. switch	CH type 8360 KZ
			60A181
			60A175
			60A123

MODEL S-36A PARTS LIST

Ref. Symbol	Name of Part and Description	Function	Mfr Code and Type No.	Hallcrafters Part No.
SW <sub>7A</sub>	<p>Switch, rotary selector: 3 section 3 position; 2 shields separate section #1 from rest of the assembly; a single pole A-C power switch is included at rear and is open at position #1, and closed in positions #2 and #3; all metal parts silver plated brass except for stainless steel index spring and ball; vacuum wax impregnated phenolic wafers; shorting type rotor contacts; frame 11" long including special mtg. bracket at rear of assembly; front of assembly mounts by 3/8-32 bushing 1/2" long, shaft 1" long x 1/4" dia.</p>	<p>SELECTIVITY control and A.C switch</p>	<p>OM type H</p>	<p>60B178</p>
SW <sub>7B</sub>				
SW <sub>7C</sub>				
SW <sub>7D</sub>				
SW <sub>7E</sub>				
SW <sub>8A</sub>	<p>Switch, rotary selector: single section 2 position; all metal parts silver plated brass except for stainless steel index spring and ball; vacuum wax impregnated phenolic wafer; non shorting teeth at contacts 5 and 8; frame 5/16" long, mounts by 3/8-32 bushing 1/2" long; shaft 1" long x 1/4" dia.</p>	<p>A.M./F.M. switch</p>	<p>OM type QH</p>	<p>60A177</p>
SW <sub>8B</sub>				
SW <sub>8C</sub>				
SW <sub>8D</sub>				
SW <sub>9</sub>	<p>Switch, rotary selector; 3 circuit; single section 4 position; metal parts brass, fungicide treated bakelite wafer; shorting type contacts; 1-3/8" lg x 1-7/16" wd x 1-5/8" h overall; shaft 1/2" lg x 1/4" dia.; mtg by 3/8-32 x 1/2" lg brass bushing.</p>	<p>TONE switch</p>	<p>OM Special</p>	<p>60B212</p>
SW <sub>10</sub>	<p>Switch, toggle, DPDT, rated 3 amperes @ 250 V., 1-3/4" long x 21/32" wide x 5/8" deep, mounted by bushing 13/32" long threaded 15/32-32, solder lug contacts.</p>	<p>115/230 volt A-C change over</p>	<p>HH</p>	<p>60A090</p>

**TRANSFORMERS**

T <sub>1</sub>	<p>Transformer, R-F: 27.8 to 47 megacycles; one primary and one secondary winding; primary 1-<math>\frac{1}{2}</math> turns of #30SCE single layer winding with a Q of 85 at 44 megacycles with 96.8 micro-microfarads; secondary 5 turns of #22 D cel. single layer winding with a Q of 163 at 26 megacycles with 93.5 micro-microfarads; air cores; coils wound on a xx bakelite tube 1-5/8" long x <math>\frac{1}{8}</math>" O.D. x 3/8" I.D.; solder lug terminals.</p>	Coupling between antenna and grid of tube V <sub>1</sub> for band 1	SWI type 651	51A265
T <sub>2</sub>	<p>Transformer, R-F: 46 to 82 megacycles; one primary and one secondary winding; primary 1-<math>\frac{1}{2}</math> turns of #30SCE single layer winding with a Q of 67 at 45 megacycles with 105 micro-microfarads; secondary 1-7/8 turns of #18 D cel. braid single layer winding with a Q of 158 at 45 megacycles with 99 micro-microfarads; air cores; coils wound on a bakelite tube 1-5/8" long x <math>\frac{1}{8}</math>" O.D. x 3/8" I.D., solder lug terminals.</p>	Coupling between antenna and grid of tube V <sub>1</sub> for band 2	SWI type 654	51A268
T <sub>3</sub>	<p>Transformer, R-F: 62 to 143 megacycles; one primary and one secondary winding; primary 3-<math>\frac{1}{2}</math> turns of #28 braided cel. single layer winding; secondary 1-<math>\frac{1}{2}</math> turns of #14 solid copper single layer winding; air cores; coils wound on a solid form 3/4" long x <math>\frac{1}{4}</math>" dia.; extended coil winding leads for terminals.</p>	Coupling between antenna and grid of tube V <sub>1</sub> for band 3	SWI type 657	51A792
T <sub>4</sub>	<p>Transformer, R-F: 27.8 to 47 megacycles; one primary and one secondary winding; primary 28-<math>\frac{1}{2}</math> turns of #34SCE single layer winding; secondary 6 turns of #22 D cel. braid; air cores; coils wound on a bakelite tube 1-5/8" long x <math>\frac{1}{8}</math>" O.D. x 3/8" I.D.; solder lug terminals.</p>	Coupling between tubes V <sub>1</sub> and V <sub>2</sub> for band 1	SWI type 652	51B793

MODEL S-36A PARTS LIST

Ref. Symbol	Name of Part and Description	Function	Mfr Code and Type No.	Hallicrafter's Part No.
T <sub>6</sub>	Transformer, R-F: 46 to 82 megacycles; one primary and one secondary winding; primary 11- $\frac{1}{2}$ turns of #34SCE single layer winding (wound counter-clockwise), secondary 2- $\frac{1}{2}$ turns of #22 D cel. braid single layer winding (wound clockwise); air cores; coils wound on a bakelite tube 1- $\frac{5}{8}$ " long x $\frac{1}{8}$ " O.D. x $\frac{3}{8}$ " I.D.; solder lug terminals.	Coupling between tubes V <sub>1</sub> and V <sub>2</sub> for band 2	SWI type 655	51B794
T <sub>6</sub>	Transformer, R-F: 82 to 143 megacycles; one secondary winding; primary 2- $\frac{3}{4}$ turns of #36SCE single layer winding; secondary 3- $\frac{1}{4}$ turns of #14 solid copper single layer winding; air cores; coils are wound on a solid bakelite from 7- $\frac{1}{8}$ " long x $\frac{1}{4}$ " dia.; extended coil winding leads for terminals.	Coupling between tubes V <sub>1</sub> and V <sub>2</sub> for band 3	SWI type 658	51A776
T <sub>7</sub>	Transformer, R-F: 27.8 to 47 megacycles; one primary and two secondary windings; primary 1- $\frac{3}{4}$ turns of #34SCE; first secondary 4- $\frac{1}{8}$ turns of #22 D cel. braid; second secondary 2- $\frac{1}{2}$ turns of #30DCE; air cores; coils are wound on a bakelite tube 1- $\frac{5}{8}$ " long x $\frac{1}{2}$ " O.D.; solder lug terminals.	Tuned circuit of oscillator stage for band 1	SWI type 653	51A267
T <sub>8</sub>	Transformer, R-F: 46 to 82 megacycles; one primary and two secondary windings; primary 3- $\frac{1}{4}$ turn of #30S cel. braid; first secondary 2- $\frac{1}{2}$ turns of #18D cel. braid; second secondary $\frac{1}{2}$ turn of #22D cel. braid; air cores; coils are wound on a bakelite tube 1- $\frac{5}{8}$ " long x $\frac{1}{2}$ " O.D.; solder lug terminals.	Tuned circuit of oscillator stage for band 2	SWI type 656	51A270

T <sub>9</sub>	<p>Transformer, R-F: 82 to 143 megacycles; one primary and two secondary windings; primary <math>\frac{1}{2}</math> turn of #26 plain enamel; first secondary 1 turn of #14 bare copper wire; second secondary 1-<math>\frac{1}{2}</math> turns of #26S cel. braid; air core; coils are wound on xx bakelite tube 1-5/8" long x 3/8" dia.; one solder lug and extended coil winding leads provide terminals.</p>	Tuned circuit of oscillator stage for band 3	SWI type 659	51B778
T <sub>10</sub>	<p>Transformer, intermediate-frequency: 5.25 megacycles; one primary and three secondary windings; primary 16<math>\frac{1}{2}</math> turns single layer winding on adjustable polyiron core assembly; first secondary 1<math>\frac{1}{2}</math> turns single layer winding on same form as primary; second secondary 21<math>\frac{1}{2}</math> turns single layer winding on adjustable polyiron core assembly; third secondary 2<math>\frac{1}{2}</math> turns wound on same form as second secondary; fixed trimmer capacitors (C<sub>68</sub>) and (C<sub>69</sub>), a fixed resistor (R<sub>10</sub>) and a fixed capacitor (C<sub>12</sub>) complete the assembly; aluminum shield can 4" high x 1-7/8" long x 1-7/16" wide with 4 spade lugs centered one on each side of shield; solder lug terminals at base numbered 1 thru 8 and a 7<math>\frac{1}{2}</math>" insulated stranded wire lead brought out through a hole in the side of the shield provide connections.</p>	Coupling between tubes V <sub>2</sub> and V <sub>3</sub>	EW Special	50C140
T <sub>11</sub>	<p>Transformer, intermediate-frequency: 5.25 megacycles; one primary and three secondary windings; primary 16<math>\frac{1}{2}</math> turns single layer winding on adjustable polyiron core assembly; first secondary 1<math>\frac{1}{2}</math> turn winding on same form as primary; second secondary 20 turns single layer winding on adjustable polyiron core assembly; third secondary 2<math>\frac{1}{2}</math> turn winding on same form as second secondary; fixed trimmer capacitors (C<sub>70</sub>) and (C<sub>71</sub>), a fixed resistor (R<sub>19</sub>) and a fixed capacitor (C<sub>16</sub>) complete the assembly; aluminum shield can 4" high x 1-7/8" long x 1-7/16" wide with 4 spade lugs centered one on each side of shield mounted 9/32" from base; solder lug terminals at the base numbered 1 thru 8 provide connections.</p>	Coupling between tubes V <sub>3</sub> and V <sub>4</sub>	EW Special	50C141

MODEL S-36A PARTS LIST

Ref. Symbol	Name of Part and Description	Function	Mfr Code and Type No.	Hallicrafter's Part No.
T <sub>12</sub>	<p>Transformer, intermediate-frequency: 5.25 megacycles; one primary and three secondary windings; primary 16½ turns single layer winding on adjustable polyiron core assembly; first secondary 1½ turn winding on same form as primary; second secondary 20½ turns single layer winding on adjustable polyiron core assembly; third secondary 2½ turn winding on same form as second secondary; fixed trimmer capacitors (C<sub>72</sub>) and (C<sub>73</sub>), complete the assembly; aluminum shield can 4" high x 1-7.8" long x 1-7.16" wide with 4 spade lugs centered one on each side of shield mounted 9.32" from base; solder lug terminals at base numbered 1 thru 8 provide connections.</p>	<p>Coupling between tubes V<sub>4</sub> and V<sub>5</sub></p>	<p>EW Special</p>	<p>50C142</p>
T <sub>13</sub>	<p>Transformer, intermediate-frequency: 5.25 megacycles; one primary and one secondary winding; primary 31½ turns single layer winding on adjustable polyiron core assembly; secondary 31½ turns single layer winding on adjustable polyiron core assembly; fixed trimmer capacitors (C<sub>76</sub> and C<sub>77</sub>) complete the assembly; aluminum shield can 4" high x 1-7.8" long x 1-7.16" wide with 4 spade lugs centered one on each side of shield mounted 9.32" from base; solder lug terminals at base numbered 1 thru 8 provide connections.</p>	<p>Coupling between tubes V<sub>5</sub> and V<sub>6</sub></p>	<p>EW Special</p>	<p>50C143</p>
T <sub>14</sub>	<p>Transformer, discriminator: 5.25 megacycles; one primary and one secondary winding; primary 33 turns single layer winding on adjustable polyiron core assembly; secondary 35 turns center tapped single layer winding on polyiron core assembly; fixed trimmer capacitors (C<sub>74</sub> and C<sub>75</sub>), and a fixed coupling capacitor (C<sub>29</sub>) complete the assembly.</p>	<p>Coupling between tubes V<sub>7</sub> and V<sub>8</sub></p>	<p>EW Special</p>	<p>50C144</p>

<p>T<sub>15</sub></p> <p>bly; aluminum shield can 4" high x 1-7/8" long x 1-7/16" wide with 4 spade lugs centered one on each side of shield mounted 9/32" from base; solder lug terminals at base numbered 1 thru 8 provide connections.</p> <p>Transformer, A-F: one primary and 2 secondary windings; primary to match a 12,000-ohm push-pull load @ 35 ma. for each tube; first secondary to match a load of 600 ohms, center tapped; second secondary to match a load of 5000 ohms; iron core; case hermetically sealed; vacuum impregnated; coil and core assemblies bolted to brackets spot welded to case, solder lugs terminals marked 1 through 8 at base of transformer, 4 mtg. lugs at base with 3-1/16" x 1-11/16" mtg. centers; breakdown between windings and core 1000 R.M.S. volts.</p>	<p>Coupling between audio out-put tubes V<sub>11</sub> and V<sub>12</sub> and load</p>	<p>ST type 10A40</p>	<p>55C062</p>
<p>T<sub>16</sub></p> <p>Transformer, power: primary, 2 section winding connected in parallel for 115 V. A-C, and connected in series for 230 V. A-C operation, 50/60 cycles, single phase; first secondary center tapped to provide 270 V. D-C @ 150 milliamperes across 10 mfd. capacitor and a 2 henry 85 ohm choke with a 50K6 rectifier tube; second secondary 6.4 V. A-C @ 4 amperes; third secondary 5 V. A-C @ 3 amperes; hermetically sealed case 4-15/16" long x 3-3/4" deep x 5-5/16" high spot welded at all joints; coil and core assemblies bolted to brackets spot welded to case; vacuum impregnated; mounted by 4 lugs at base with 3-5/8" x 2-3/8" mtg. centers; 4 terminals threaded 8-32 NC-2 connected to primary as follows: 1 and 3 to one section of primary, 2 and 4 to other section of primary; 7 solder lug terminals connected as follows; 5 and 6 connect to secondary #2 (6.4 V. A-C), 7 and 8 connect to secondary #3 (5 V. A-C), 9 and 11 connect to secondary #1 (540 V. A-C), 10 is center tap for secondary #1 and ground for transformer case and core, iron core; breakdown voltages as follows between windings and core and case; primary - 1500 V. RMS, secondary #1-2500 V. RMS, secondary #2-1500 V. RMS, secondary #3-2500 V. RMS.</p>	<p>A-C power transformer</p>	<p>ST type 10F51</p>	<p>52C084</p>



MODEL S-36A PARTS LIST

Ref. Symbol	Name of Part and Description	Function	Mfr Code and Type No.	Hallcrafters Part No.
<b>TERMINAL BOARDS</b>				
TS <sub>1</sub>	Board, terminal: output; consists of vacuum impregnated natural linen bakelite mtg. board 3½" long x 2" wide x 1/8" thick with 4 mtg. holes 0.144" dia. and having 2-7/8" x 1-5/8" mtg. centers, marked "600 OHM CENTER TAP - GND. and 500 OHM, 5000 OHM-GND", six brass knurled thumb screw binding posts provide electrical connection.	500 ohm, 5000-ohm and center tap of 600-ohm output connections	H Special	41X5306
TS <sub>2</sub>	Board, terminal: antenna input; consists of natural paper bakelite mtg. board 4-5/16" long x 2-¼" wide x 3/16" thick with 4 mtg. holes 0.144" dia. and having 3-13/16" x 2" mtg. centers; marked A <sub>1</sub> , A <sub>2</sub> , GND; 3 brass knurled thumb screw binding posts provide electrical connections.	Antenna connections	H Special	41X5308
<b>TUBES</b>				
V <sub>1</sub>	Tube, acorn pentode	R-F amplifier	RCA type 956	90X856
V <sub>2</sub>	Tube, acorn pentode	Converter	RCA type 954	90X854
V <sub>3</sub>	Tube, R-F pentode; same as V <sub>7</sub>	1st I-F amplifier	RCA type 6AC7	90X6AC7
V <sub>4</sub>	Tube, R-F pentode	2nd I-F amplifier	RCA type 6AB7	90X6AB7
V <sub>5</sub>	Tube, R-F pentode	3rd I-F amplifier	RCA type 6SK7	90X6SK7
V <sub>6</sub>	Tube, double diode; same as V <sub>8</sub>	A-M second detector	RCA type 6H6	90X6H6
V <sub>7</sub>	Same as V <sub>3</sub>	F-M limiter	-	-

V <sub>8</sub> V <sub>9</sub>	Same as V <sub>6</sub> Tube duo-triode	F-M discriminator Audio voltage amplifier	- RCA type 6SL7GT	- 90X6SL7GT
V <sub>10</sub>	Tube, gas filled diode	Voltage regulator	RCA type VR-150/30	90XVR-150/30
V <sub>11</sub>	Tube, beam power amplifier; same as V <sub>12</sub>	Audio power amplifier	RCA type 6V6GT/G	90X6V6GT/G
V <sub>12</sub> V <sub>13</sub>	Same as V <sub>11</sub> Tube, full wave diode	Audio power amplifier Plate supply rectifier	- RCA type 5U4G	- 90X5U4G
V <sub>14</sub>	Tube, triode amplifier	Beat frequency oscillator	RCA type 6J5	90X6J5
V <sub>15</sub>	Tube, acorn triode	High frequency oscillator	RCA type 955	90X955

## G. INDEX TO PARTS MANUFACTURERS

Symbol	Manufacturer	Symbol	Manufacturer
AP	American Phenolic Corp. Chicago, Illinois	IC	Industrial Condenser Chicago, Illinois
ASA	Any manufacturer meeting the applicable American Standards Association specifications.	IRC	International Resistance Co. Philadelphia, Pa.
B	Belden Mfg. Co. Chicago, Illinois	IF	Littlefuse, Inc. Chicago, Illinois
BC	Brenner Chemical Co. Chicago, Illinois	MCM	McClintock Meter Co. Minneapolis, Minn.
CE	Coronet Electric Co. Chicago, Illinois	MN	Meissner Manufacturing Co. Mt. Carmel, Illinois
CH	Cutler-Hammer Milwaukee, Wis.	MT	The Muter Co. Chicago, Illinois
CRL	Centralab Milwaukee, Wis.	OM	Oak Manufacturing Co. Chicago, Illinois
CT	Chicago Telephone & Supply Co. Elkhart, Indiana	RC	Radio Condenser Corp. Chicago, Illinois
ER	Erie Resistor Erie, Pa.	RCA	RCA Manufacturing Co., Inc., Camden, N. J.
EW	Electronic Winding Corp. Chicago, Illinois	ST	Standard Transformer Corp. Chicago, Illinois
GE	General Electric Co. Schenectady, N. Y.	SWI	S.W. Inductor Co. Chicago, Illinois
H	The Hallicrafters Co. Chicago, Illinois	U	Utah Products Company Chicago, Illinois
HH	Hart & Hegeman Electric Co. Hartford, Conn.	UE	Underwood Electric Co. Chicago, Illinois

*The* **hollcrafters** *co.*

SCHEMATIC DIAGRAM-RADIO RECEIVER CHL-46131

